

# THE IX AGE FANTASY BATTLES



## Scenarios

Supplement

2<sup>nd</sup> Edition, version x.1 beta 2 hotfix 1 – December 26, 2019



The 9<sup>th</sup> Age: Fantasy Battles is a community-made miniatures wargame.

All rules and feedback can be found and given at: [the-ninth-age.com](http://the-ninth-age.com)

All changes are listed on: [the-ninth-age.com/archive.html](http://the-ninth-age.com/archive.html)

Copyright Creative Commons license: [the-ninth-age.com/license.html](http://the-ninth-age.com/license.html)

## Introduction

While you can find several scenarios in the main Rulebook for The 9<sup>th</sup> Age: Fantasy Battles in the form of the standard Deployment Types and Secondary Objectives, we have received requests for additional scenarios.

In this Supplement, you will find a number of scenarios that are less focused on balanced tournament play but have a stronger focus on narrative play.

This Supplement consists of three different sections, for three different types of scenarios: Gaming Scenarios, Narrative Scenarios, and Add-Ons.

The first section features a list of simple Gaming Scenarios that are intended to be used as an alternative to the default scenarios of The 9<sup>th</sup> Age: Fantasy Battles. Usually, they only change the rules for Deployment and the Secondary Objective and thus can be used in everyday gaming, without any special preparations.

The second part consists of Narrative Scenarios, which completely change Deployment Types and victory conditions, have special rules, and may even change the rules for army building. Therefore you need to agree on such a scenario with your opponent before building your army. Narrative Scenarios offer more narrative aspects, and can easily be included in a campaign. Note that the victory conditions are not necessarily symmetrical, and the balance is less guaranteed than in Gaming Scenarios.

And finally, you can find several Add-Ons at the end of this document that comprise small changes of the rules, so that you can use them in any standard game or scenario to bring even more flavour and fun to your game.

You will find figures illustrating the deployment rules for each scenario in the corresponding section. Note that the scenarios are intended to be played on a standard board (72" wide and 48" deep). If you wish to play on a smaller or larger board, you will need to adjust the length specifications in the figures accordingly.

## Table of Contents

Gaming Scenarios	3
Narrative Scenarios	23
Add-Ons	42

# Gaming Scenarios

These scenarios are intended to be used for everyday gaming, and can be played using any armies and normal Terrain, replacing the normal Deployment Types and Secondary Objectives in the Rulebook.

Each Gaming Scenario consists of the following elements:

**Deployment** – The Deployment Type used in the scenario. This can be one of the standard Deployment Types but it can also be unique. If so, everything needed to carry out the Deployment will be specified.

**Pre-Game Set-up** – Which steps to perform place before the battle begins, such as placing tokens for the Secondary Objective.

**Scenario Special Rules** – Any unique rules that affect the armies or the Battlefield in this scenario.

**Winning the Secondary Objective** – How to win the Secondary Objective. If there is a winner of the Secondary Objective, that player gains 3 additional Battle Points while the loser of the Secondary Objective loses 3 Battle Points, as usual.

## Scenario Chart

You can use the following chart to randomly determine which scenario to play. Roll a D3 to choose the scenario bracket (see the table below), and then roll a D6 to determine the exact scenario to be played.

D3 Result	D6 Result	Scenario	Page
1	1	Misdirections	4
1	2	Hidden Treasures	5
1	3	Dark Visions	6
1	4	Lost Ruins	7
1	5	Ancient Artefact	8
1	6	The Adversary's Task	9
2	1	The Long March Home	10
2	2	Meteor Shower	11
2	3	The Holy Grail	12
2	4	The Hidden Kings	13
2	5	Despoilers	13
2	6	Dominating the Field	15
3	1	Barrel of Stout	16
3	2	Escape from Beyond the Veil	17
3	3	Carnage	18
3	4	Hold the Line	19
3	5	Foul Manners	20
3	6	Multiple Objectives	21

## 1 – 1. Misdirections

*Both you and your foe have a clue of where the secrets of these lands are hidden. Play it carefully, and you might figure out your opponent's clue, but also make sure your own bluff isn't seen through.*

### Deployment

Standard Deployment Type: Counterthrust.

### Pre-Game Set-up

After determining Deployment Zones, both players alternately place two markers each on the Battlefield, starting with the player that chose their Deployment Zone. Each marker has to be placed with its center on a point that is within 6" of the Centre Line and at least 6" away from the Board Edge. In the figure below, this area is marked in orange. In addition, each marker must be placed with its centre at least 11" away from any other marker's centre and more than 1" away from Impassable Terrain.

Label the markers with numbers from 1 to 4. During step 7 of the Deployment Phase Sequence, each player secretly chooses one of the markers (write down its number on a piece of paper). Players may choose freely between markers placed by themselves and by their opponent.

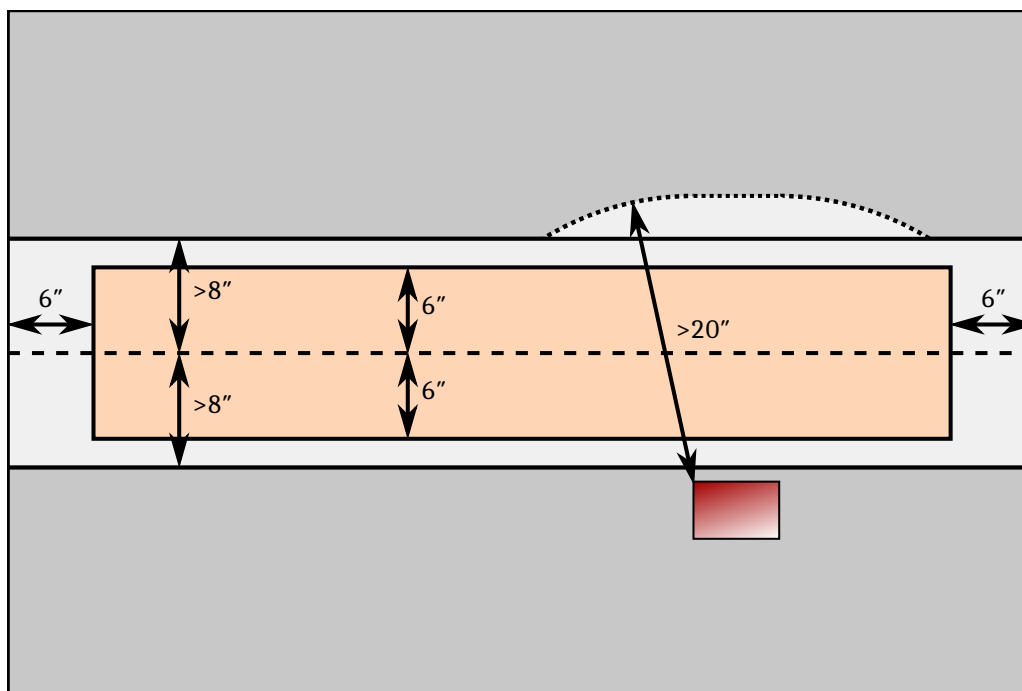

### Special Scenario Rules

At the end of Game Turn 5, both players reveal which marker they chose.

### Winning the Secondary Objective

At the end of the game, the player controlling most of the chosen markers wins this Secondary Objective. A marker is controlled by the player with the most Scoring Units within 6" of the centre of the marker. If a unit is within 6" of the centre of both markers, it only counts as within 6" of the centre of the marker which is closest to its Centre (randomise if both markers' centres are equally close).

## 1 – 2. Hidden Treasures

*You didn't have time to decipher the treasure map fully before setting off. Take whatever opportunity you can as more secrets are revealed.*

### Deployment

Standard Deployment Type: Frontline Clash.

### Pre-Game Set-up

Mark the positions 1, 2, and 3 on the board as shown in the figure below.

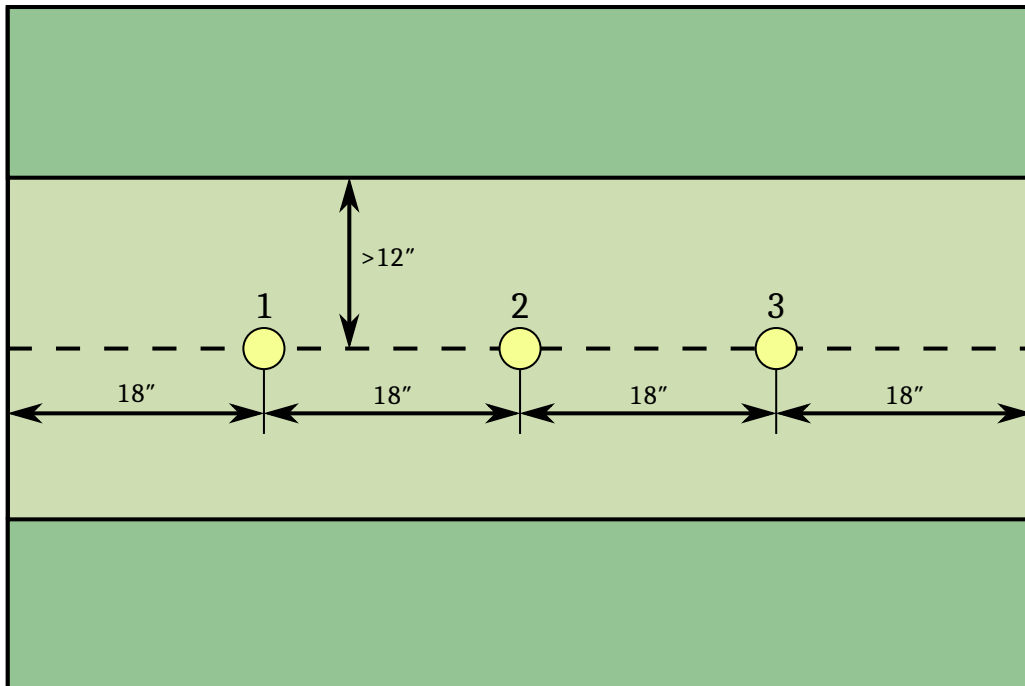

### Special Scenario Rules

At the start of each Game Turn, roll a D3. Place a Treasure Marker with its centre on the Centre Line, at the position corresponding to the result of the dice. If there is already one marker at the position, don't place any markers during this Game Turn.

### Winning the Secondary Objective

At the end of the game, the player who controls the most Treasure Markers wins this Secondary Objective. A Treasure Marker is controlled by the player with the most Scoring Units within 6" of the centre of the marker. If a unit is within 6" of the centres of more than one marker, it only counts as within 6" of the centre of the marker which is closest to its Centre (randomise if both markers' centres are equally close).

## 1 – 3. Dark Visions

*An evil presence haunts these lands. Its will at times manifests itself to you, compelling you to lead its next victim to feed its insatiable hunger. Please the spirit and you may go safely.*

### Deployment

Standard Deployment Type: Encircle.

### Pre-Game Set-up

Place a small Impassable Terrain Feature (approximately 3×3") suitable to represent the source of The Gaze in the centre of the board, or, if there already is another Terrain Feature there, as close as possible to the centre of the board, but at least 1" away from other Terrain Features. In case you don't have any suitable Impassable Terrain Feature available, you may mark the centre of the board as the source of The Gaze with a marker instead.

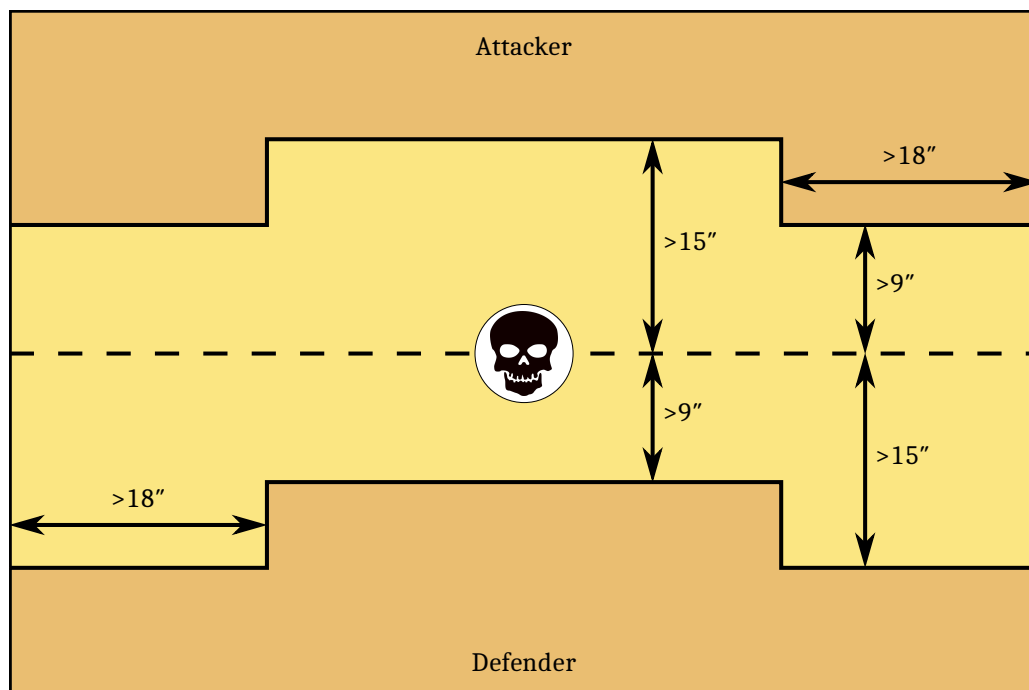

### Special Scenario Rules

At the start of each Player Turn, roll a D6 and consult the table below to determine which enemy unit is targeted by The Gaze.

---

D6 Result	Target for The Gaze
-----------	---------------------

- |     |   |
|-----|---|
| 1-2 | The enemy Scoring Unit closest to the centre of the source of The Gaze                  |
| 3-4 | The enemy War Machine or Gigantic model closest to the centre of the source of The Gaze |
| 5-6 | The enemy unit (of any kind) closest to the centre of the source of The Gaze            |
- 

If a result is not applicable, roll the D6 again until it is. The Gaze remains on a unit until the end of the game. If two or more potential targets of The Gaze are equally close to the centre of the source of The Gaze, randomise which of these units is targeted.

### Winning the Secondary Objective

The player who has the lowest number of units under The Gaze removed as casualties at the end of the game wins this Secondary Objective.

## 1 – 4. Lost Ruins

*Mist shrouds these long forgotten ruins, though somewhere a treasure is hidden. You cannot risk sending your entire force in at once, going forward without a vanguard would be foolish.*

### Deployment

Deployment Zones are areas more than 14" away from the Centre Line.

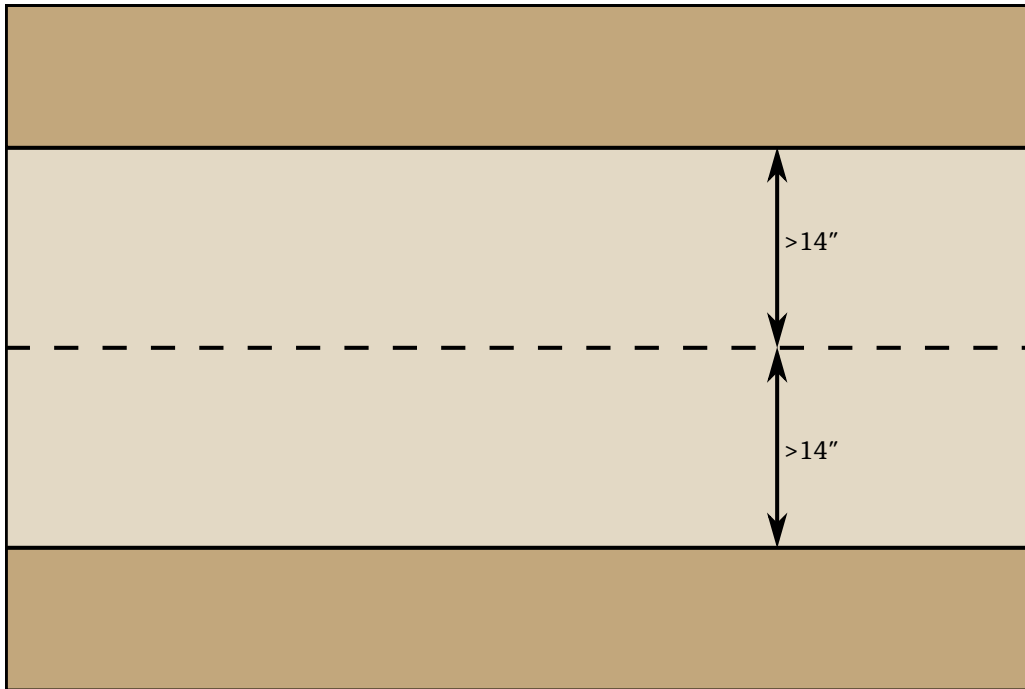

### Pre-Game Set-up

During step 6 of the Pre-Game Sequence, immediately after it has been determined which player will be choosing their Deployment Zone but before the choice has been made, the player not choosing their Deployment Zone must choose a single Terrain Feature on the Battlefield. This Terrain Feature is known as the Lost Vault.

When declaring Special Deployment, during step 8 of the Pre-Game Sequence, both players alternately choose two of their units each to gain **Vanguard**, starting with the player that chose their Deployment Zone. Lone Characters cannot be chosen.

### Winning the Secondary Objective

At the end of the game, the player with the most Scoring Units within 6" of the Lost Ruins wins this Secondary Objective.

## 1 – 5. Ancient Artefact

*Your army was drawn here by the rumours of a valuable artefact of a forgotten age, but so was the army of your foe. Show them who's boss!*

### Deployment

Standard Deployment Type: Refused Flank.

### Pre-Game Set-up

Place a small Impassable Terrain Feature (approximately 3×3") suitable to represent the Ancient Artefact in the centre of the board, or, if there already is another Terrain Feature there, as close as possible to the centre of the board, but at least 1" away from other Terrain Features. In case you don't have any suitable Impassable Terrain Feature available, you may mark the centre of the board as the Ancient Artefact with a marker instead.

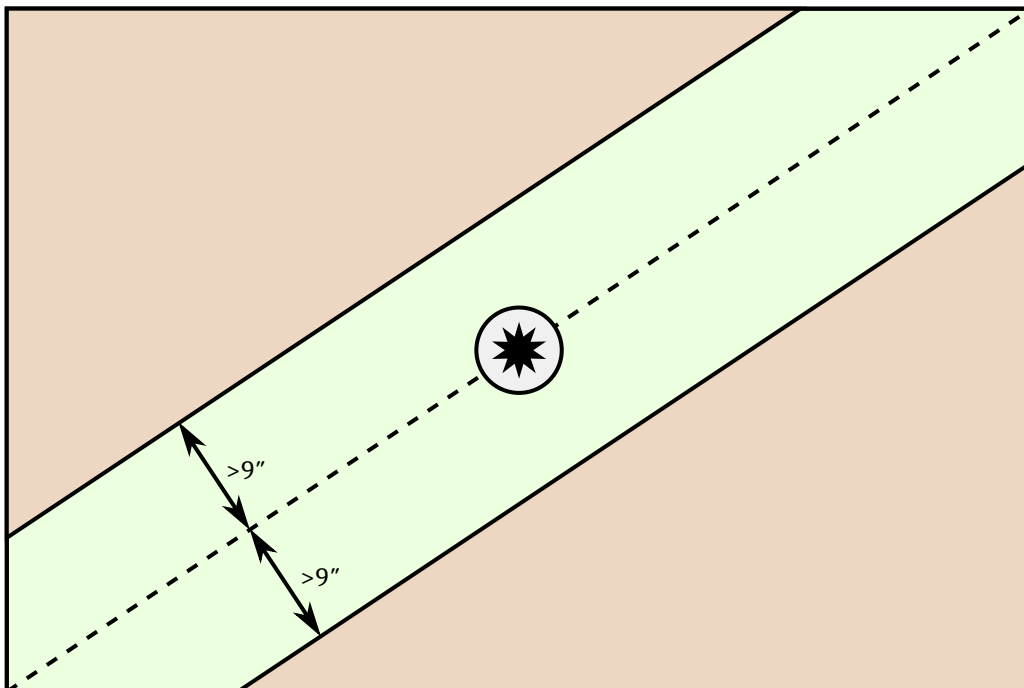

### Scenario Special Rules

The game lasts for a random number of turns. At the end of the 4<sup>th</sup> Game Turn, roll a D6. On a roll of 2+, play a 5<sup>th</sup> Game Turn. At the end of the 5<sup>th</sup> Game Turn roll a D6. On a roll of 3+, play a 6<sup>th</sup> Game Turn, etc.

At the end of each Game Turn after the first, the player with the most Scoring Units within 6" of the Ancient Artefact gains a counter.

The General and the Battle Standard Bearer of both armies gain **Scoring**.

### Winning the Secondary Objective

At the end of the game, the player with the most counters wins this Secondary Objective.



## 1 – 6. The Adversary’s Task

*Vanadra, Goddess of Wrath, has shown you the faces of all those who have wronged you. Now is your chance to claim justice!*

### Deployment

Deployment Zones are areas more than 10” away from the Centre Line. Characters cannot be deployed within 18” of the short Board Edges.

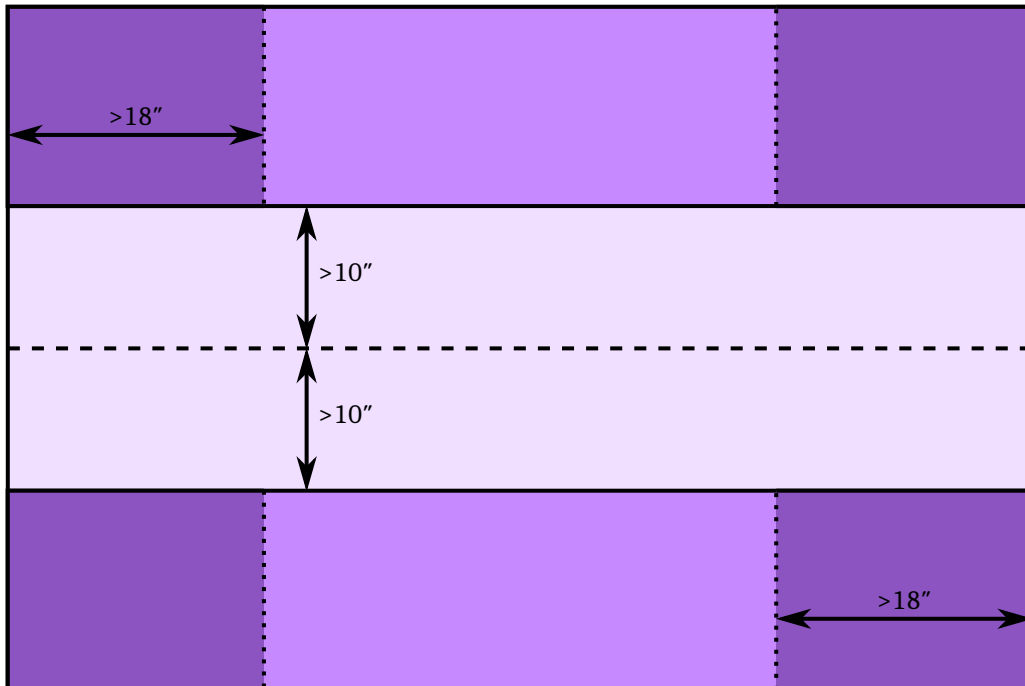

### Scenario Special Rules

During step 7 of the Deployment Phase Sequence (after moving Vanguarding units and before rolling for first turn), both players take turns in openly choosing three Characters from their opponent’s Army List, starting with the player that finished deploying first. If there are less than three Characters in an Army List, the opponent automatically chooses all Characters instead. Characters currently not on the board (e.g. if Ambushing) may still be chosen.

### Winning the Secondary Objective

At the end of the game, the player that has the highest number of their chosen Characters still alive wins this Secondary Objective.

## 2 – 1. The Long March Home

*The long war is just about over, and your army has just started the long march home, only to find your path blocked by yet another foe. Push past them as quickly as you can, and if some were to fall, that just means a few less mouths to feed on the way home.*

### Deployment

Standard Deployment Type: Marching Columns.

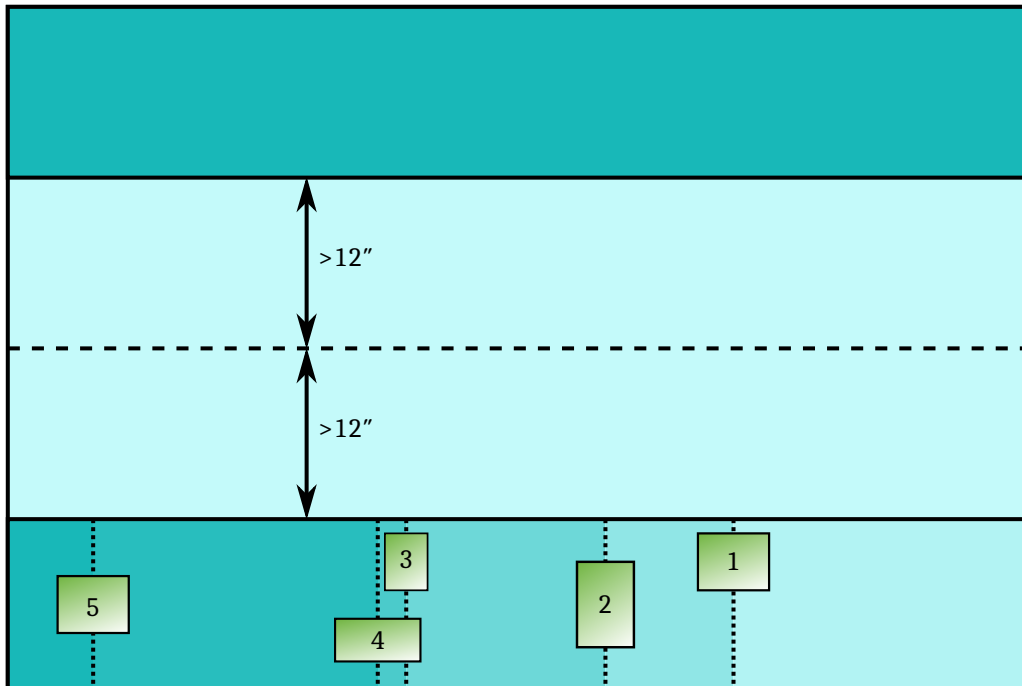

### Pre-Game Set-up

Once a player has deployed all of their units (excluding units that use Special Deployment such as Ambush or Scout) and declared his intent to go first or second, that player must place a marker with its centre within their opponent's Deployment Zone. The other player then deploys their remaining units and places a marker with its centre within their opponent's Deployment Zone. Continue with step 5 of the Deployment Phase Sequence (deployment of Scouting units) as usual.

### Scenario Special Rules

When calculating Victory Points, Core Units are worth half of their normal Point Cost (also when Fleeing and/or Shattered).

### Winning the Secondary Objective

The player with the most Scoring Units within 6" of the marker they placed at the end of the game wins this Secondary Objective.

## 2 – 2. Meteor Shower

The area has been showered with meteors containing valuable Darkstone. This material has strange properties, but it just might be used to your advantage as you collect the meteor remains.

### Deployment

Standard Deployment Type: Counterthrust.

### Pre-Game Set-up

After step 8 of the Pre-Game Sequence (immediately before the Deployment Phase), place 5 meteor markers with their centres evenly along the Centre Line (each 12" apart). Then move each marker  $D6 \times 2$ " in a random direction. If a '6' is rolled, the marker is not moved at all. Finally, adjust the position of each marker by the minimal amount until it's centre is 1" clear of all Impassable Terrain if necessary.

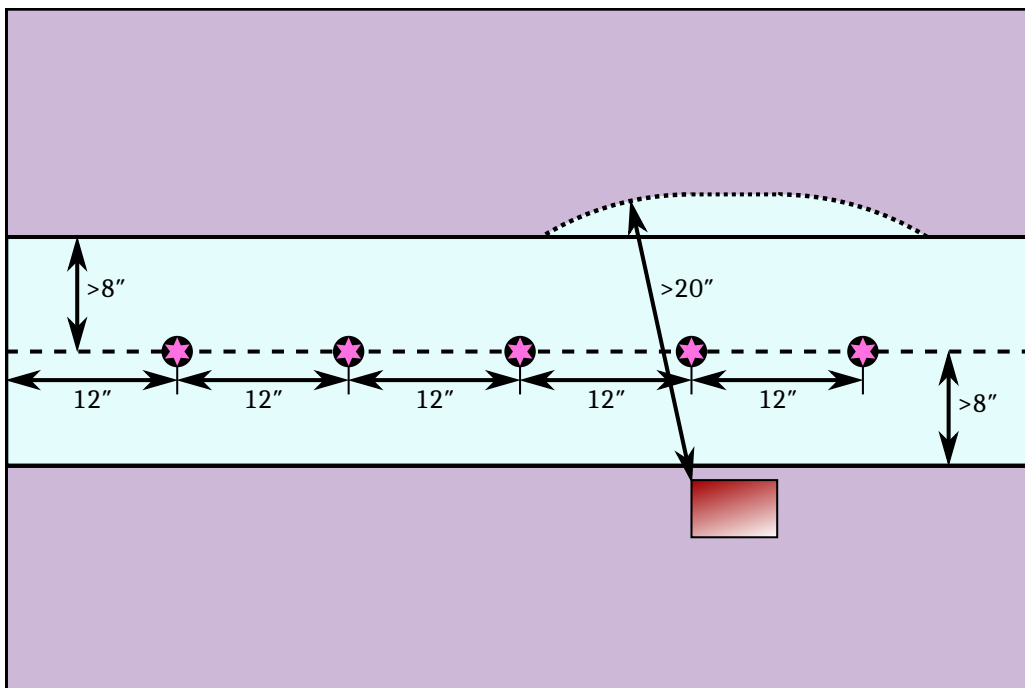

### Scenario Special Rules

At the start of each of your Player Turns, except for the first, any of your units may pick up meteor markers whose centre they are in contact with. Remove the marker from the Battlefield: the unit is now carrying the marker. Units carrying a marker with less than 3 Full Ranks cannot perform March Moves.

If a unit that is carrying markers is destroyed or loses Scoring, the opponent must immediately place all markers carried by this unit with their centres on points within 3" of it. These points cannot be within 1" of Impassable Terrain or the centres of other meteor markers, but can be inside a unit.

Non-Bound Spells cast by models in units carrying one or more meteor markers must reroll all Magic Dice that result in a '1'. If the Caster would do so normally, it also gains a +1 Casting Modifier.

### Winning the Secondary Objective

At the end of the game, the player whose Scoring Units carry the most meteor markers wins this Secondary Objective. Note that non-Scoring units may pick up markers but do not count towards winning this Secondary Objective.

## 2 – 3. The Holy Grail

### Deployment

Standard Deployment Type: Counterthrust.

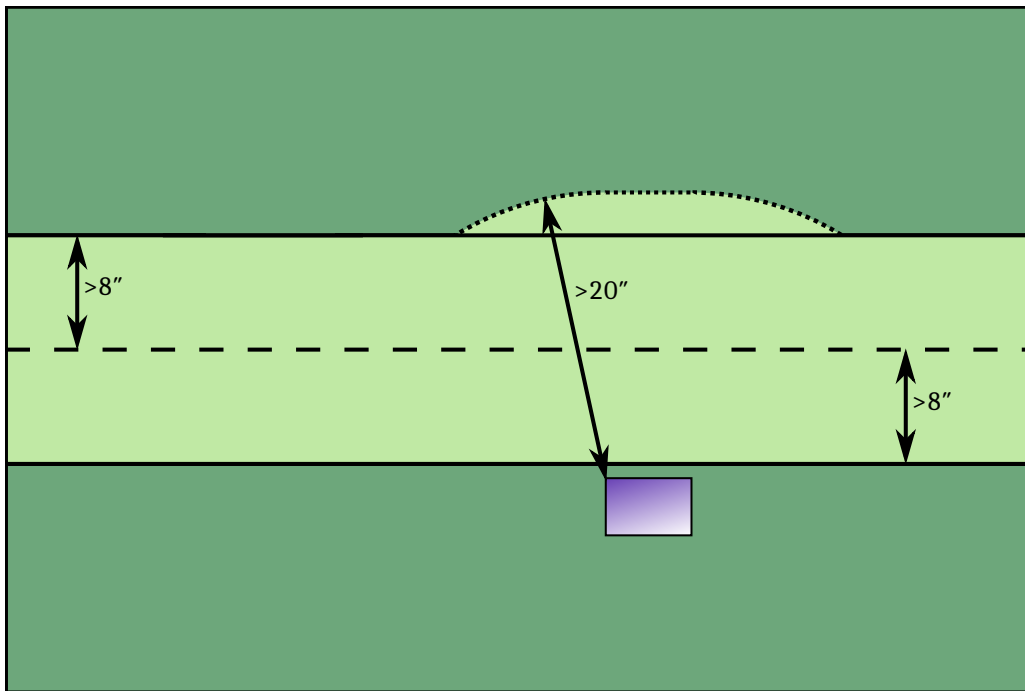

### Pre-Game Set-up

After Spell Selection (at the end of step 7 of the Pre-Game Sequence), the players take turns marking 3 different Terrain Features (in total) that are not Impassable Terrain and that are not entirely within their Deployment Zone, starting with the player that chose their Deployment Zone.

During step 7 of the Deployment Phase Sequence (after moving Vanguarding units and before rolling for first turn), both players secretly choose which of the marked Terrain Features the Grail is hidden in (write it down on a piece of paper).

### Scenario Special Rules

At the start of Game Turn 2, the choices of Terrain Features are revealed. If both players chose the same one, place the Grail Marker at the centre of that Terrain Feature. Otherwise, place the Grail Marker at the centre of the marked Terrain Feature none of the players chose.

At the start of each following Player Turn, any of the Active Player's Scoring Units may pick up the Grail Marker if they are in contact with its centre. Remove the marker from the Battlefield: the unit is now carrying the marker. Units carrying the marker with less than 3 Full Ranks cannot perform March Moves.

If a unit that is carrying the Grail Marker is destroyed or Flees, the opponent must immediately place the marker with its centre on a point within 3" of the unit. This point cannot be within 1" of Impassable Terrain, but can be inside a unit.

### Winning the Secondary Objective

At the end of the game, if a unit is carrying the Grail Marker, its owner wins this Secondary Objective.

## 2 – 4. The Hidden Kings

*Two scheming lords vie for the throne and the time has come for a decisive battle. However, they will both need to be in the thick of it at the point of victory to claim absolute authority in the moment of victory.*

### Deployment

Deployment Zones are areas more than 10" away from the Centre Line. Only models that are Cavalry, have Light Troops and/or Scout may be deployed within 12" of the short Board Edges.

When declaring Special Deployment, players may choose to keep up to two of their units as reinforcement. These units follow the rules for Ambushing units, except that they automatically arrive in Game Turn 1, and must be placed touching the owner's long Board Edge.

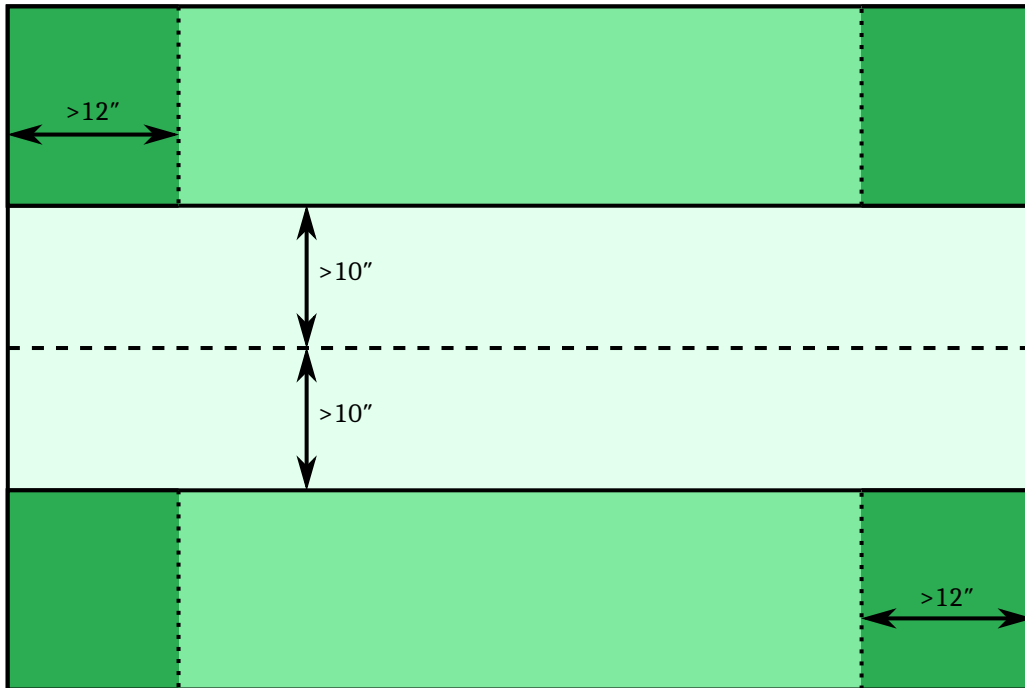

### Pre-Game Set-up

Immediately before determining the Deployment Zones, both players must secretly choose one of the following:

- Any friendly non-Character unit to conceal the army's Hidden King
- Any friendly Character to be the army's Hidden King

Write the chosen unit/Character down on a piece of paper.

### Scenario Special Rules

At the start of each Player Turn, the Active Player may choose one of the Reactive Player's units. This player must reveal if the Hidden King resides in this unit. He doesn't have to reveal who the Hidden King is in the unit.

### Winning the Secondary Objective

At the end of the game, if your Hidden King is alive and the opponent's has been removed as a casualty, you win this Secondary Objective.

## 2 – 5. Despoilers

*Do not let the enemy despoil your flags!*

### Deployment

Deployment Zones are areas more than 10" away from the Centre Line. Only models that are Cavalry, have Light Troops and/or Scout may be deployed within 12" of the short Board Edges.

When declaring Special Deployment, players may choose to keep up to two of their units as reinforcement. These units follow the rules for Ambushing units, except that they automatically arrive in Game Turn 1, and must be placed touching the owner's long Board Edge.

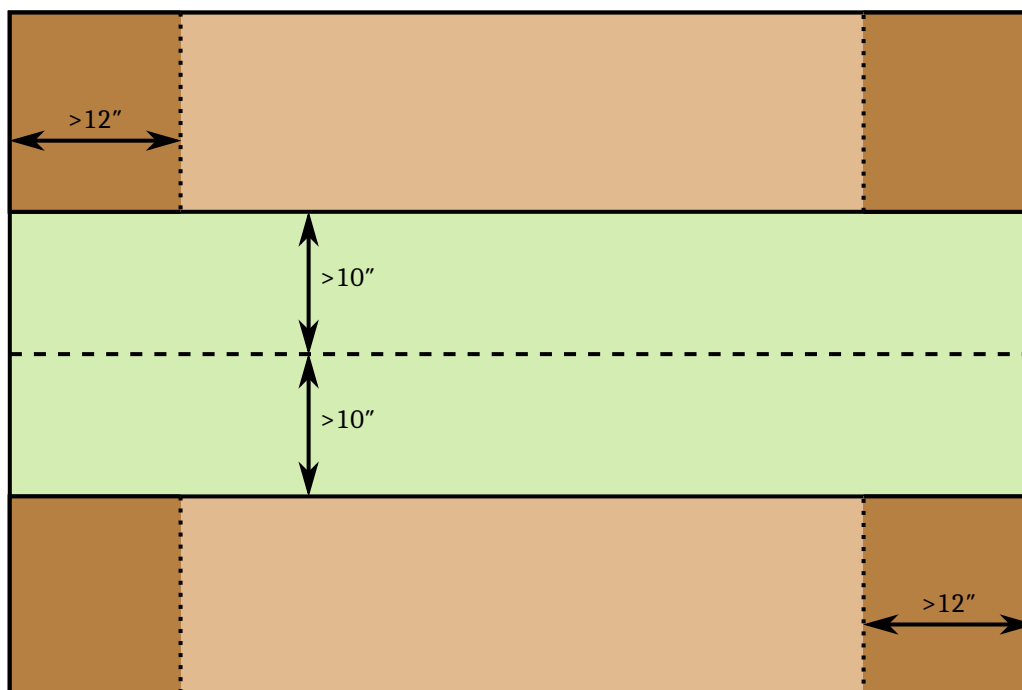

### Pre-Game Set-up

During step 7 of the Deployment Phase Sequence (after moving Vanguarding units and before rolling for first turn), both players take turns in openly choosing three units with a Standard Bearer (excluding the Battle Standard Bearer) from their opponent's Army List, starting with the player that finished deploying first. If there are less than three units with a Standard Bearer in an Army List, the opponent automatically chooses all units with a Standard Bearer instead. If there are none in the army, the opponent chooses a single Scoring Unit instead. Units currently not on the board (such as Ambushing units) may still be chosen.

### Winning the Secondary Objective

At the end of the game, the player that has the highest number of their chosen units still alive wins this Secondary Objective.

## 2 – 6. Dominating the Field

*Claim the field of battle, to claim victory as well!*

### Deployment

The board is divided into quarters by two straight lines through the centre of the board, parallel to the Board Edges. Deployment Zones are two opposite corners, and more than 10" away from the centre of the board.

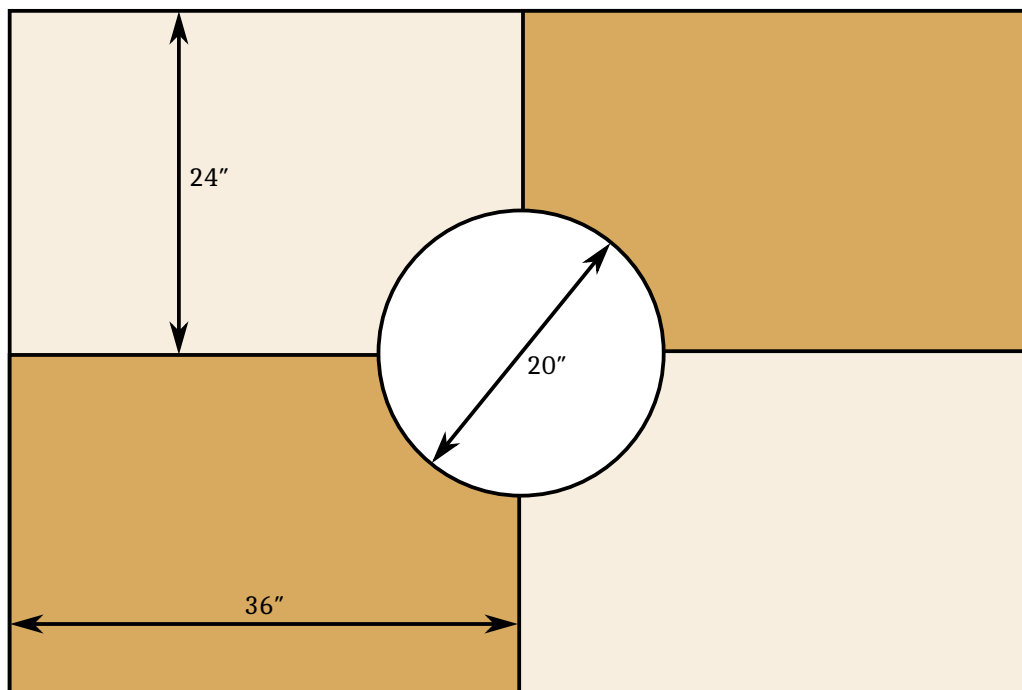

### Winning the Secondary Objective

At the end of the game, players are awarded Victory Counters for each zone in which they have at least one Scoring Unit:

- The opponent's Deployment Zone – 3 counters
- The zones adjacent to the Deployment Zones – 2 counters each
- Your own Deployment Zone – 1 counter
- The centre zone – 0 counters

A unit is considered to be in a zone if its Centre is inside it.

The player with the most Victory Counters wins this Secondary Objective.

### 3 – 1. Barrel of Stout

*What is sweeter than the taste of victory? A nice barrel of stout might do the trick!*

#### Deployment

Standard Deployment Type: Dawn Assault.

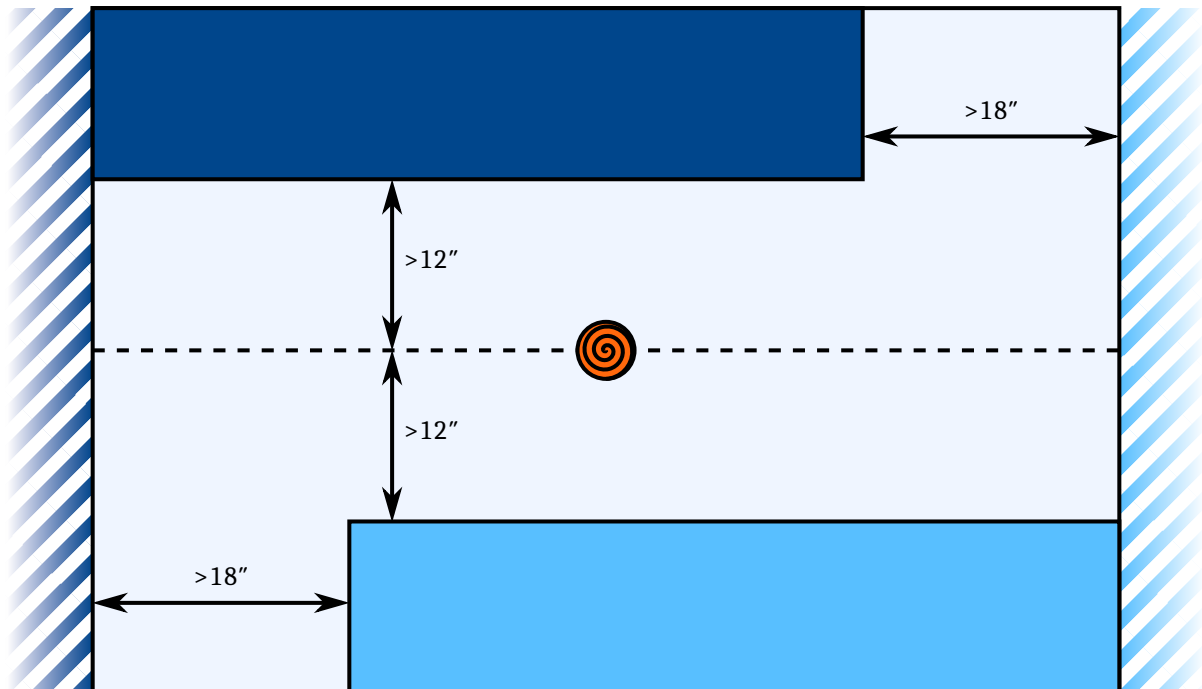

#### Pre-Game Set-up

Place the Stout Marker at the centre of the board.

#### Scenario Special Rules

At the start of each of your Player Turns, except for the first, any of your Scoring Units may pick up the Stout Marker if they are in contact with its centre. Remove the marker from the Battlefield: the unit is now carrying the marker.

Units carrying the marker with less than 3 Full Ranks cannot perform March Moves.

If a unit that is carrying the Stout Marker is destroyed or Flees, the opponent must immediately place the marker with its centre on a point within 3" of the unit. This point cannot be within 1" of Impassable Terrain, but can be inside a unit.

The unit carrying the Stout Marker gains **Fearless**.

#### Winning the Secondary Objective

At the end of the game, if a unit is carrying the Stout Marker, its owner wins the Secondary Objective.



## 3 – 2. Escape from Beyond the Veil

*Trapped on the other side of the Veil, your only way to escape is to gain the favour of the Dark Gods!*

### Deployment

Standard Deployment Type: Frontline Clash.

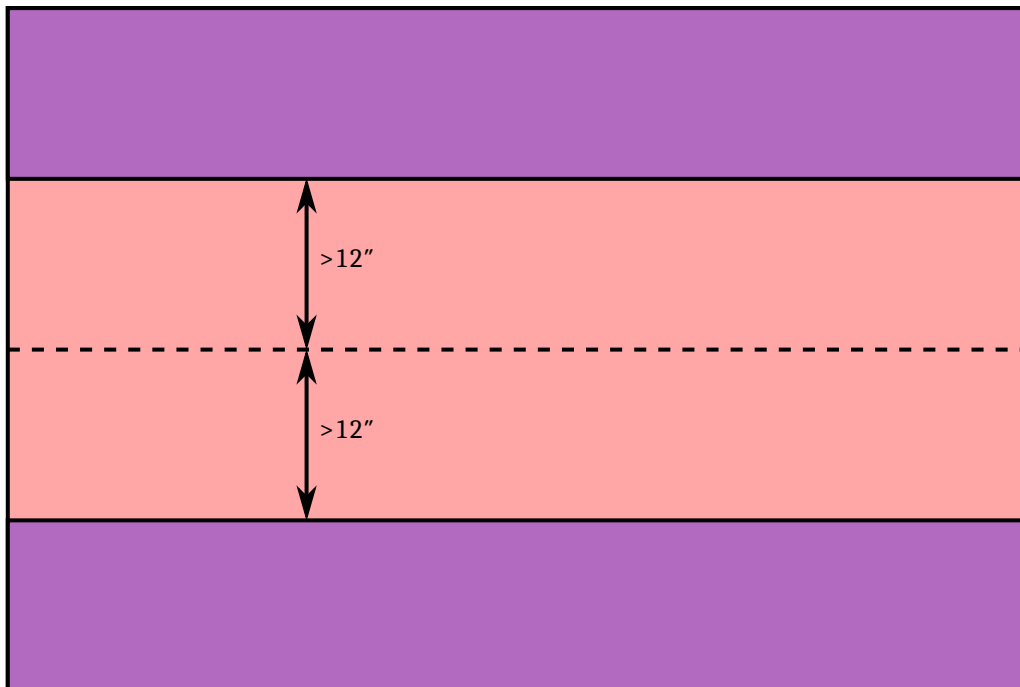

### Winning the Secondary Objective

Players are awarded Victory Counters during the battle when the following events occur:

- Each time an enemy Scoring Unit is removed as a casualty – 2 counters
- Each time an enemy Character is killed in a Duel – 2 counters
- The first time a friendly non-Fleeing Scoring Unit is inside the enemy Deployment Zone – 2 counters
- The first time a friendly unit without Unbreakable or Unstable passes a Break Test – 1 counter
- Each time an enemy unit performs a Flee Charge Reaction – 1 counter
- Each time a friendly unit successfully Charges an enemy unit in the Flank or Rear – 1 counter

At the end of the game, the player with the most Victory Counters wins this Secondary Objective.

### 3 – 3. Carnage

*Sometimes there are no tactics, or plans. Just rage and blood.*

#### Deployment

Standard Deployment Type: Dawn Assault.

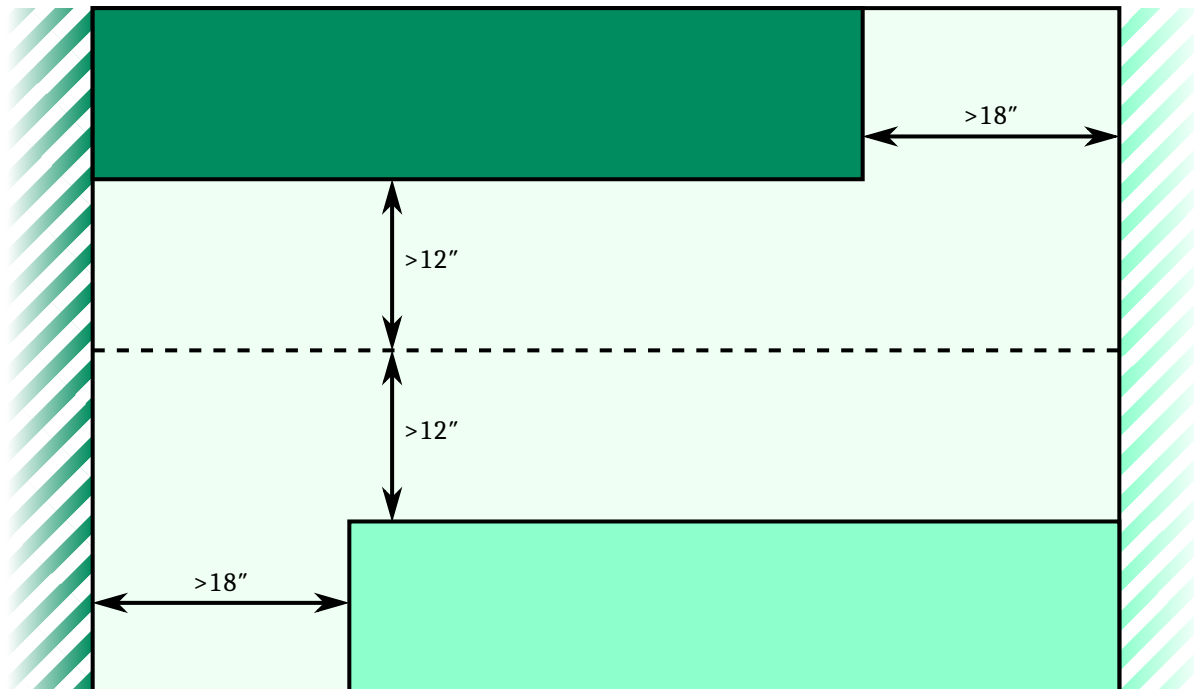

#### Winning the Secondary Objective

Each time an enemy unit is removed as a casualty while Engaged in Combat, when Breaking from Combat, or during the Flee Move directly after Breaking from Combat, you gain a Victory Counter. At the end of the game, the player with the most Victory Counters wins this Secondary Objective.

### 3 – 4. Hold the Line

*Bravery and valour, strength and movement.*

#### Deployment

Standard Deployment Type: Marching Columns.

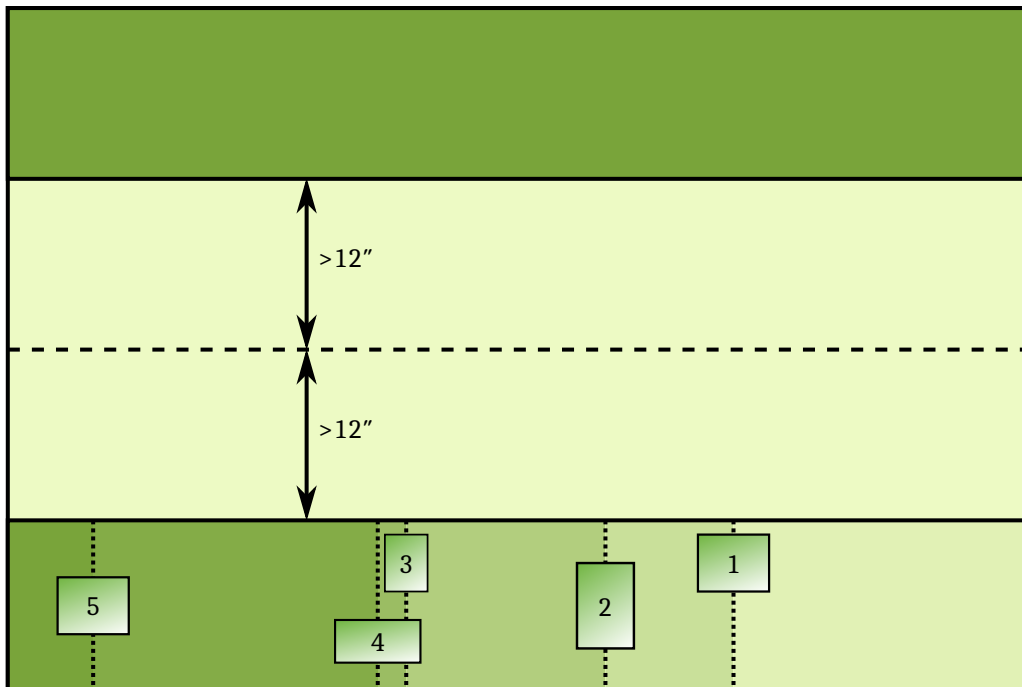

#### Pre-Game Set-up

At the end of step 8 of the Deployment Phase Sequence (after rolling for first turn), the player with the first turn is declared the Attacker and their opponent is declared the Defender. Three of the Defender's units that did not use Special Deployment may immediately make a Flying Movement of up to 6". They must end their movement fully inside their Deployment Zone.

#### Scenario Special Rules

Charge Range rolls made by the Attacker's Scoring Units are subject to Maximised Roll.

#### Winning the Secondary Objective

At the end of the game, the player with the most Scoring Units inside the Defender's Deployment Zone, up to a maximum of 3, wins this Secondary Objective.

## 3 – 5. Foul Manners

*Some units have such a despicable reputation on the battlefield, that just seeing them causes lines to be disrupted.*

### Deployment

Standard Deployment Type: Refused Flank.

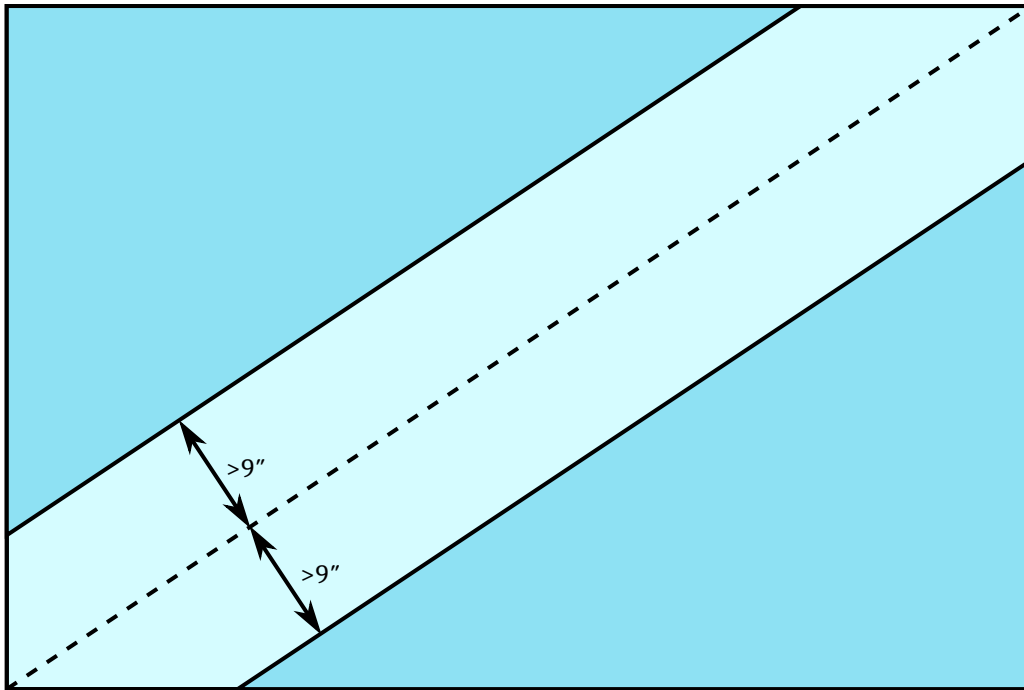

### Pre-Game Set-up

During step 7 of the Deployment Phase Sequence (after moving Vanguarding units and before rolling for first turn), both players must choose one of their own units, starting with the player that finished deploying first. The chosen units gain **Foul Manners**.

### Scenario Special Rules

#### Foul Manners

All units gain **Frenzy** with the exception that only enemy units with Foul Manners trigger a Frenzy Test for this instance of Frenzy.

Each time an enemy unit fails a Frenzy Test triggered by a unit with Foul Manners, you gain a Victory Counter. If the enemy unit is Scoring, you gain an additional Victory Counter.

### Winning the Secondary Objective

At the end of the game, the player with the most Victory Counters wins this Secondary Objective.

## 3 – 6. Multiple Objectives

### Deployment

Any of the standard Deployment Types.

### Pre-Game Set-up

After step 8 of the Pre-Game Sequence (immediately before the DeploymentPhase), each player generates 3 Tasks for themselves from the list below, starting with the player that chose their Deployment Zone. To generate a Task, roll a D3 and a D6.

### Winning the Secondary Objective

At the end of the game, the player who has completed the most of their assigned Tasks wins this Secondary Objective.

---

D3 Result	D6 Result	Task
1	1	<b>Many Spies have Many Eyes</b> All enemy units with Scout must be removed as casualties at the end of the game. If there are no units with Scout in the opponent's Army List, all enemy units with Vanguard must be removed as casualties at the end of the game instead. Generate another Task if there are no units with Scout or Vanguard in the opponent's Army List.
1	2	<b>Knowledge is Power</b> Immediately choose a Wizard in your army. That Wizard must still be alive at the end of the game. Generate another Task if there is no Wizard in your army.
1	3	<b>There can be Only One</b> You must have exactly one Character still alive at the end of the game. Generate another Task if you only have a single Character in your Army List. Unless selected as a mount for a Character, War Platforms are ignored for this Task.
1	4	<b>Steal their Land</b> You must have at least one Scoring Unit inside the enemy Deployment Zone at the start of any of your first four Player Turns. Units that used Special Deployment are ignored for this purpose.
1	5	<b>Seize that Resource</b> Immediately choose a Terrain Feature completely outside your Deployment Zone. You must have more Scoring Units within 6" of that Terrain Feature than your opponent at the end of Game Turn 5.
1	6	<b>Spring the Trap</b> At least one of your units must successfully Charge an enemy unit in the Rear Facing.

---

D3 Result	D6 Result	Task
2	1	<b>Precious Cargo</b> Immediately choose a Scoring Unit in your army. That Scoring Unit must still be alive at the end of the game.
2	2	<b>Honour is Everything</b> None of your units must ever declare a Flee Charge Reaction (not even involuntarily). Generate another Task if there are no units in your Army List that can declare a Flee Charge Reaction.
2	3	<b>Onwards Men</b> Your Battle Standard Bearer must successfully Charge an enemy unit and survive until the end of the following Player Turn at least once. Generate another Task if there is no Battle Standard Bearer in your Army List.
2	4	<b>Bring It Down!</b> Immediately choose a model with Towering Presence in the opponent's army. That model must have been removed as a casualty before the end of Game Turn 4. Generate another Task if there are no models with Towering Presence in the opponent's Army List.
2	5	<b>Thinning Out the Herd</b> When you generate this Task, identify the unit with the most models in your Army List. In case of a tie, choose one of them. That unit must have been removed as a casualty by the end of the game.
2	6	<b>Assassination</b> The enemy General must be removed as a casualty before your own General is removed as a casualty.
3	1	<b>Domination</b> You must have more Scoring Units within 6" of the centre of the board than your opponent at the end of the game.
3	2	<b>Clear the Skies</b> All enemy models with Fly must be removed as casualties at the end of the game. Generate another Task if there are no models with Fly in the opponent's Army List.
3	3	<b>Magical Relic</b> Immediately place a Relic Marker with its centre inside your Deployment Zone. Each time a friendly model successfully casts a non-Bound non-Attribute Spell, you may move the Relic Marker up to 3" in any direction. There must never be any enemy units within 6" of the Relic Marker's centre at the beginning of any of your Players Turns.
3	4	<b>Mutiny</b> Your General must have been removed as a casualty and at least one of your other Characters must still be on the board by the end of the game. Generate another Task if there is only a single Character in your Army List.
3	5	<b>Message</b> Immediately choose a Character in your army. That Character must be inside the opponent's Deployment Zone at the start of at least one of your Player Turns during Game Turn 4 or later.
3	6	<b>Target Strike</b> Immediately choose an enemy Scoring Unit. That unit must have been removed as a casualty by the end of the game.

# Narrative Scenarios

These scenarios contain more complex ideas and rules than the Gaming Scenarios. They can require unique Terrain Features or one or more specific armies to participate. They can also include uneven Army Points, with one side having a significantly larger force than the other.

Therefore these scenarios are not intended for balanced competitive play but for more entertaining games that tell a story.

Each Narrative Scenario contains detailed explanations on how it should be used as indicated in the following headings:

**Deployment** – The Deployment Type used in the scenario. This can be one of the standard Deployment Types but it can also be unique. If so, everything needed to carry out the Deployment will be specified.

**Pre-Game Set-up** – Which steps to perform before the battle begins, such as placing tokens for the objectives, or any restrictions pertaining to Army Lists.

**Scenario Special Rules** – Any unique rules that affect the armies or the Battlefield in this scenario.

**Winning the Scenario** – How to win the game. Most Narrative Scenarios have an original way of determining the winner, different from counting Battle Points.

Number	Scenario	Page
1	<a href="#">The Gates of Greed</a>	24
2	<a href="#">The Treasure of the Dragon</a>	26
3	<a href="#">Great Portals of the Barren Mountains</a>	28
4	<a href="#">Divine Intervention</a>	30
5	<a href="#">An Eye in the Future</a>	31
6	<a href="#">Mission Impossible</a>	32
7	<a href="#">March to Victory</a>	33
8	<a href="#">Strategic Objections</a>	34
9	<a href="#">A Proper Battle</a>	36
10	<a href="#">Weather the Storm</a>	37
11	<a href="#">Runaway Train</a>	39
12	<a href="#">In the Mountains</a>	40

# 1. The Gates of Greed

*Deep in the Wasteland, a grim monument towers over the landscape. No one knows who built it, but its homage to Sugulag is obvious. The Collector watches over this battlefield, and those who pass through his gate will be granted a fraction of his power.*

## Deployment

Standard Deployment Type: Frontline Clash.

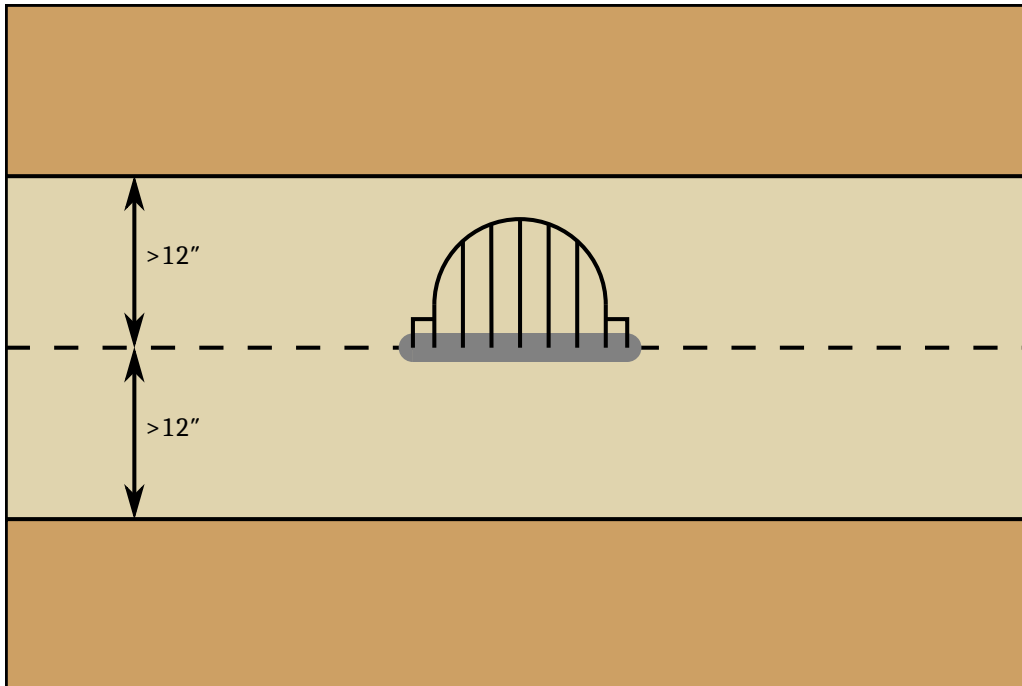

## Pre-Game Set-up

For best thematic effect, the two armies used in this scenario should have a good reason to be in the Wasteland. Among the most suitable are Warriors of the Dark Gods, Daemon Legions, Ogre Khans, and Infernal Dwarves. Among the least suitable are Saurian Ancients, Sylvan Elves, and Undying Dynasties.

Place an Icon of Greed Terrain Feature in the centre of the board. It should have a size of about 2×8" and allow units to be placed inside it (e.g. be removable from its base).

## Scenario Special Rules

### The Collector's Due

Each character participating in this battle can take an additional 50 pts worth of Special Items, Daemonic Manifestations, or Runic Items.

Whenever a Character kills an enemy model in a Duel, it may immediately claim one piece of equipment carrying a Special Item, a Daemonic Manifestation or a Runic Item carried by the slain model (including Artefacts). If so, and the Character already has a piece of equipment carrying an item of the same category, it must discard a piece of equipment carrying an item of that category of your choice to make room for the new item. For example, to claim an Enchanted Weapon (or equivalent Runic Item), the model must first discard its Enchanted Weapon to claim the new one.

Note that:

- Any used One use only items and destroyed items cannot be claimed.
- Enchanted shields and enchanted Suits of Armour are considered different categories for this purpose.



- The maximum amount of points a Character can spend on Special or Runic Items is ignored when claiming a piece of equipment.
- The usual restrictions for weapons still apply (e.g. a model on foot cannot use a Lance).
- Only Wizards can claim Special Items that are restricted to Wizards, and Wizards cannot claim Special Items that are for non-Wizards only.
- Only Characters that could normally take a Banner Enchantment can claim an Enchanted Banner.
- Otherwise you can also claim equipment that the model normally does not have access to (e.g. a Character that has only access to Light Armour can claim an enchanted Heavy Armour).

### Icon of Greed

The Terrain Feature at the centre of the board has the following rules.

- Cover** The Icon of Greed is Covering Terrain for units inside and/or behind it that contributes to Soft Cover.
- Movement** Gigantic models cannot move into or through the Icon of Greed.
- Broken Ranks** Units with more than half of their models with the centre of their base inside the Icon of Greed can never be Steadfast, unless specifically stated otherwise.
- Blessing of Sugulag** A non-Fleeing unit that is in contact with the centre of the Icon of Greed gains **Scoring** for the rest of the game, unless it was making a Flying Movement. If the unit already has Scoring, it counts double for The Grass is Greener. A unit cannot gain the Blessing of Sugulag more than once.

### Winning the Scenario

There are two objectives in the game. If both players win one each, the game is a draw. If only one player wins one of the objectives, that player achieves a minor victory. If one player wins both objectives, that player achieves a major victory. The two objectives are:

- Master Collector** At the end of the game, calculate how many points each player has in Special Items, Daemonic Manifestations, or Runic Items on models that haven't been removed as casualties (including points from items stolen using The Collector's Due), then subtract the amount of points originally spent on these items in their respective Army Lists. The player with the higher total following this calculation is the winner of this objective.
- The Grass is Greener** You must have more Scoring Units inside your opponent's Deployment Zone than they have in yours at the end of the game.

## 2. The Treasure of the Dragon

*No creature loves gold as dragons do.*

### Deployment

Standard Deployment Type: Marching Columns, with the exception that both players must choose the Dragon's short Board Edge (see below) and that no unit, not even units using Special Deployment, can be deployed in the third of the board that contains the Dragon.

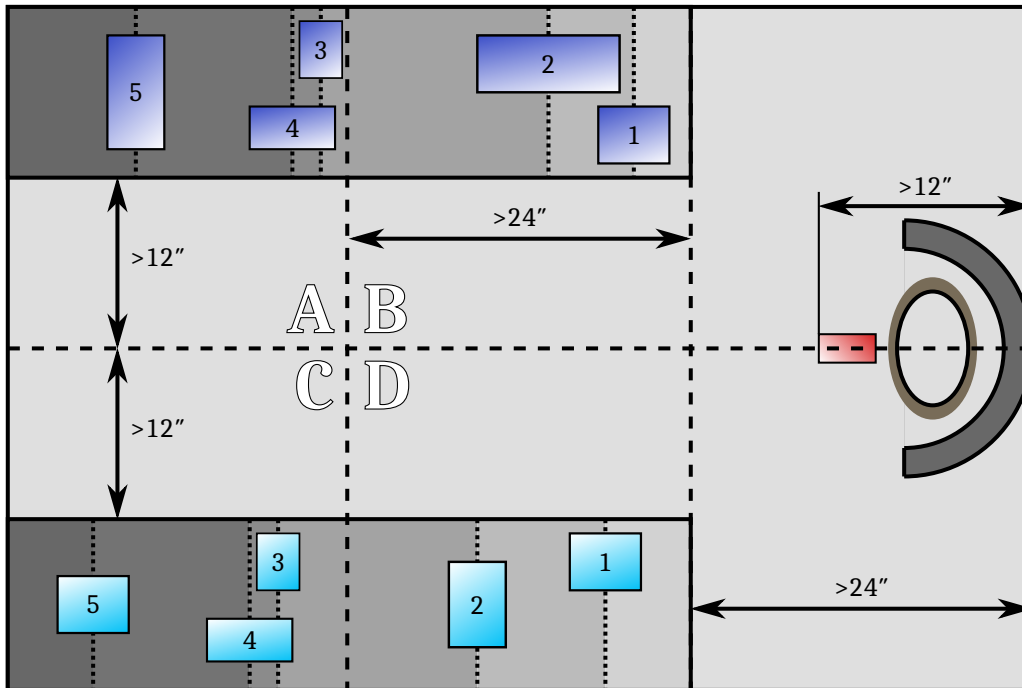

### Pre-Game Set-up

We recommend you use armies of 4500 Army Points or less in this scenario.

Build one side of the Battlefield according to the figure above. Create a half circle with Impassable Terrain on one of the short Board Edges, and place a Hill in the middle of this half circle. Place D3+1 random Terrain Features and a Forest on the rest of the board. Randomly distribute these Terrain Features in the four quarters A–D and move them 2D6" in a random direction.

Place a Dragon model where the red rectangle is and a Treasure Marker on the centre of the Hill.

### Scenario Special Rules

The Dragon is a Great Red Dragon, whose profile you'll find below. It is treated as an enemy model by both players. Rounds of Combat with the Dragon are only fought in the Player Turns of the player whose units are Engaged in Combat with the Dragon, except when units of both players are Engaged in the same Combat involving the Dragon. When calculating the Combat Score for such combats, the side with the highest Combat Score is considered to be the only winner, while all other sides count as losing the combat.



# Great Red Dragon

single model

Height Gigantic  
Type Beast  
Base 50×100 mm

Global	Adv	Mar	Dis	Model Rules		
	0"	0"	9	Fly (0", 0"), Light Troops, <b>Proud</b> , <b>Territorial</b> , Unbreakable		
Defensive	HP	Def	Res	Arm		
	6	6	6	4	Aegis (4+, against Ranged Attacks), Hard Target (1), <b>Tough Skin</b>	
Offensive	Att	Off	Str	AP	Agi	
Great Red Dragon	5	6	6	3	3	Breath Attack (Str 4, AP 1, Flaming Attacks), <b>Savage</b>

### Model Rules

**Proud:** Universal Rule.

Each Health Point lost by the Dragon counts twice when calculating the Combat Score.

**Savage:** Attack Attribute.

The target of the Dragon's Special Attacks, as well as each of its Close Combat Attacks, must be randomly determined between all possible targets available. Its Close Combat Attacks are always allocated towards the R&F models within the targeted unit, if possible (remember that the Dragon can benefit from Swirling Melee). The Dragon can only use its Breath Attack as a Melee Attack, and it does so the first time it fights a second Round of Combat.

**Territorial:** Universal Rule.

If a Scoring unit comes within 6" of the Dragon or the Treasure Marker during any move other than a Charge Move and the Dragon isn't Engaged in Combat, immediately stop that unit. Pivot the Dragon in the direction of the Centre of the unit, and then move the Dragon into base contact with the unit, as if it was Charging using a Flying Movement. The Dragon counts as Charging and this move follows all the rules for Charge Moves (i.e. the target has to declare a Charge Reaction, the rules for Maximising Contact apply, etc.). The When Charged, the Dragon's Charge Reaction is always Hold, and its Pursuit and Overrun distance is always 0".

**Tough Skin:** Personal Protection.

Attacks against the Dragon with Multiple Wounds lose this Attack Attribute.

## Winning the Scenario

At the start of each Player Turn, each player gains a Victory Counter for each of their own Scoring Units that are within 3" of the Treasure Marker and not Engaged in Combat.

You gain a Victory Counter for each unsaved wound inflicted by your units on the Dragon.

At the end of the game, the player with the most Victory Counters wins.

### 3. Great Portals of the Barren Mountains

High up in the Barren Mountains, there exist two portals, one on each side of a narrow valley. No one knows who built them or their original purpose, though their value is obvious. Beware though, for the balance of the portals' energy must be maintained.

#### Deployment

The Deployment Zones are referred as Red and Blue. Note their placement relative to the Portals in the figure below.

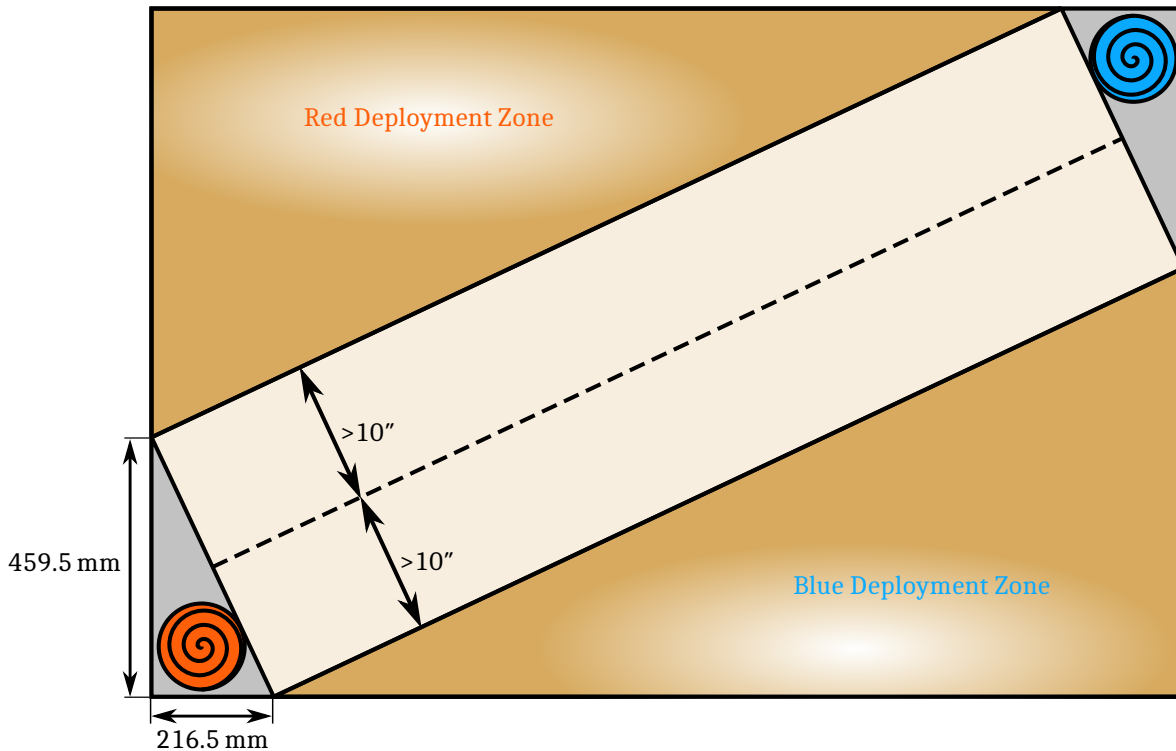

#### Pre-Game Set-up

Place the Portals in two diagonally opposite corners of the board. The bases should be triangular in shape with sides of approximately 18×8", assuming a 72×48" board.

#### Scenario Special Rules

There are two kinds of Ionisation Tokens, Red and Blue. Units that receive tokens are referred to as Ionised Units and gain **Electric Charge** (see below). A unit can only have a single Ionisation Token.

During step 7 of the Deployment Phase Sequence (after moving Vanguarding units), the players take turns marking 3 of their units each with Ionisation Tokens of the same colour as their Deployment Zone, starting with the player who finished deploying first.

#### Electric Charge – Attack Attribute

When Charging, Ionised Units have special interactions:

- Charge Range rolls against units of opposite Ionisation are subject to Maximised Roll. If such a Charge is successful, the owner of the Charging unit can choose to immediately switch the Ionisation Tokens between the Charging unit and the Charged unit (once the Charge Move is completed).
- Charge Range rolls against units of equal Ionisation are subject to Minimised Roll.

## **Portal Jumping**

When a unit ends an Advance Move fully within 5" of a Portal, it may choose to either:

- Enter it, unless it has an Ionisation of the same colour as the Portal
- Lose its Ionisation, if it is Ionized

If the unit enters the Portal, it is removed from the Battlefield and then placed back in the same formation, facing any direction, following the Unit Spacing rule, and fully within 5" of the other Portal. If this is impossible, the unit may not enter the Portal. If the teleported unit was not Ionised, it gains an Ionisation Token of the colour of the Portal it exited (e.g. exiting through a Red Portal gives a Red Ionisation).

## **Winning the Scenario**

At the end of each Player Turn, starting on Game Turn 3, the Active Player may choose to discard Ionisation Tokens from units within 6" of the centre of the board. Discarded tokens are placed in a discard pool at the side of the board. For each discarded Ionisation Token, the player gains a Victory Counter. If the discard pool (which is charged by both players) contains an equal number of Red and Blue Ionisation Tokens after this is done, the player gains an additional Victory Counter.

At the end of the game, the player with the most Victory Counters wins the game.

## 4. Divine Intervention

The gods have seen the importance of this battle and have sent their champions to assist you!

### Deployment

Any of the standard Deployment Types.

### Pre-Game Set-up

Each army gains an Incarnate Beast, whose profile you'll find in the Scenario Special Rules. It can be deployed and used as a normal part of the army.

### Scenario Special Rules

 <b>Incarnate Beast</b>						Height	Large
						Type	Beast
						Base	50×50 mm
						single model	
<i>Global</i>	<i>Adv</i>	<i>Mar</i>	<i>Dis</i>				<i>Model Rules</i>
	<b>10"</b>	<b>16"</b>	<b>9</b>				Magic Resistance (3), Supernal, Unbreakable
<i>Defensive</i>	<i>HP</i>	<i>Def</i>	<i>Res</i>	<i>Arm</i>			
	<b>8</b>	<b>5</b>	<b>5</b>	<b>2</b>	Hard Target (1)		
<i>Offensive</i>	<i>Att</i>	<i>Off</i>	<i>Str</i>	<i>AP</i>	<i>Agi</i>		
Incarnate Beast	<b>5</b>	<b>5</b>	<b>6</b>	<b>2</b>	<b>1</b>	Breath Attack (Str 4, AP 0, Divine Attacks), Divine Attacks	

### Winning the Scenario

Each time an Incarnate Beast performs any of the following actions, its owner gains a Victory Counter:

- Successfully Charges an enemy unit
- Kills an enemy Character
- Wins a Round of Combat

Each time an Incarnate Beast loses a Health Point, the opponent of its owner gains a Victory Counter.

At the end of the game, the player with the most Victory Counters wins the game.

## 5. An Eye on the Future

*Few are the ones able to foresee the future, and fewer still the ones able to do so and keep their sanity. The Oracle's prediction can help you reach glory... or madness.*

### Deployment

Any of the standard Deployment Types.

### Pre-Game Set-up

You need a model to represent the Oracle. It can typically be a Wizard, a monster, or even a tower which the Oracle is supposed to be in. During the game, that model is treated as Impassable Terrain. Place it in the centre of the board.

### Scenario Special Rules

#### The Great Oracle

At the end of your Movement Phase, you may ask the Oracle for predictions for each friendly Character that is not Fleeing and not Engaged in Combat within 3" of the Oracle. For each Character, roll a D6 and place it next to the Character, referred to as a Fate Dice. When performing one of the following actions, you may replace any single rolled D6 with the Fate Dice (this is not considered rerolling the dice).

- Casting Attempts made by the Character
- To-hit rolls for attacks made by the Character
- To-wound rolls for attacks made by the Character
- Armour Save rolls made by the Character
- Special Save rolls made by the Character
- Charge Range rolls for the Character or its unit

As long as a Character has a Fate Dice, it suffers a negative modifier to its Discipline equal to half the value of the Fate Dice, rounding fractions up. No Character can have more than a single Fate Dice.

### Winning the Scenario

The players fight to gain the loyalty of the Oracle. Each time a Character or a unit is removed as a casualty within 18" of the Oracle, and each time a unit Breaks within 18" of the Oracle, the opponent of its owner gains 1 Victory Counter. Each unit can only award a single Victory Token per phase.

At the end of the game, the player with the most Victory Counters wins the game.

## 6. Mission Impossible

*A valuable operative of the local lord has spent the last few weeks in deep cover within the enemy's ranks. Your job is to extract this agent, preferably in as glorious a manner as possible, so that he may report on your prowess to your masters.*

### Deployment

Standard Deployment Type: Frontline Clash.

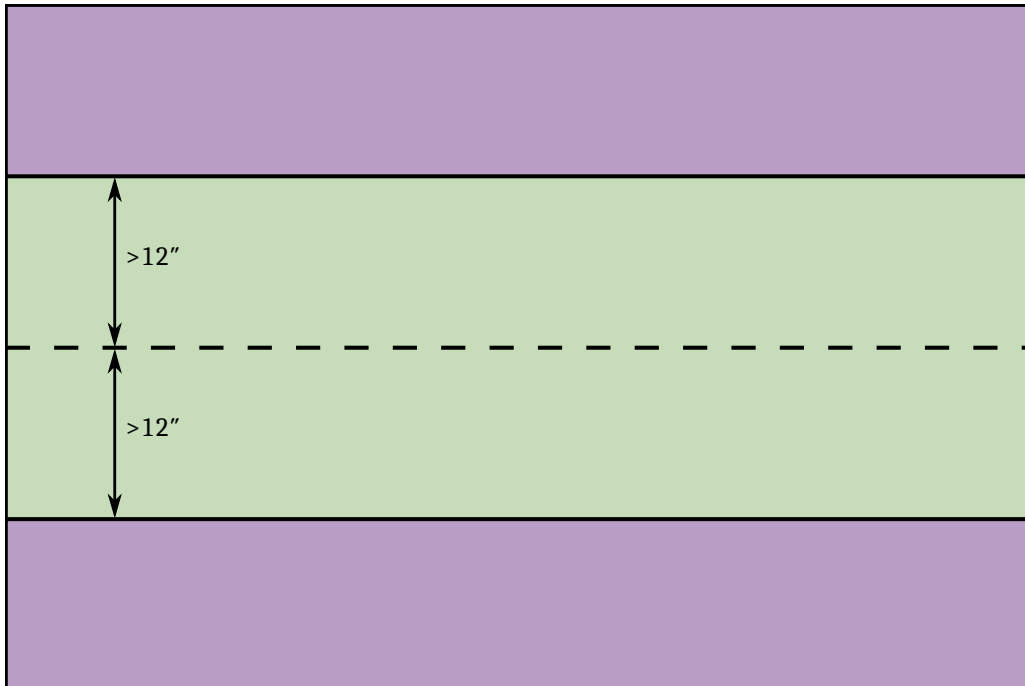

### Scenario Special Rules

#### Secret Agent

After step 8 of the Pre-Game Sequence (immediately before the Deployment Phase), both players must secretly nominate a single unit from their opponent's Army List worth at least 200 points and consisting of at least 5 models of Standard Height or 3 models of Large Height (write it down on a piece of paper). This unit contains your Spy.

At the start of your opponent's Player Turn, you can have your Spy sabotage the unit it is in. To do so, simply reveal your choice of unit. The sabotaged unit cannot Charge in the following Charge Phase and cannot voluntarily move in the following Movement Phase.

#### Winning the Scenario

To win the scenario, you must rescue your Spy in order to retrieve the valuable information collected. A Spy is considered rescued when the unit the Spy is hidden in is removed as a casualty. If you manage to rescue your Spy while your opponent doesn't rescue theirs, you win this scenario.



## 7. March to Victory

With scheduled reinforcements inbound for both sides, claiming strategically sound positions in the local area becomes all the more important to make sure a decisive victory can be had at a later point.

### Deployment

Standard Deployment Type: Frontline Clash, with the exception that units may not be deployed within 12" of the short Board Edges.

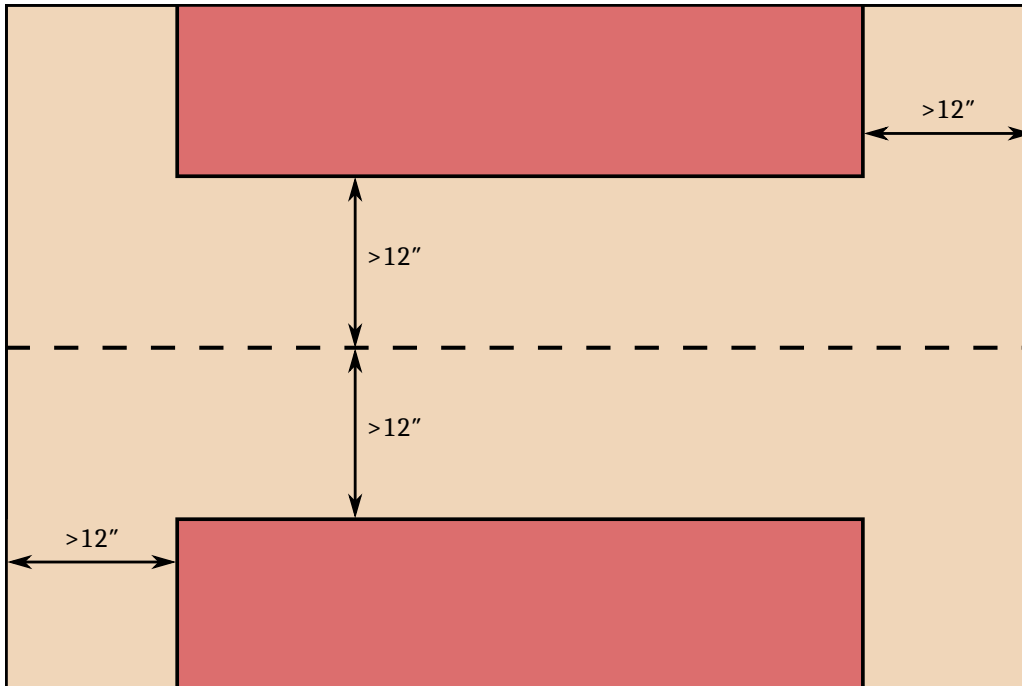

### Pre-Game Set-up

One player is the Attacker and the other player is the Defender. This is randomised at the beginning of step 6 of the Pre-Game Sequence (before determining Deployment Zones). The Attacker gets the first turn.

### Winning the Scenario

The Attacker receives bonus Battle Points for having friendly units inside the Defender's Deployment Zone at the end of the game, while the Defender receives points for preventing that. Determine the Battle Points as usual, add up the combined Point Costs of the Attacker's non-Fleeing units inside the Defender's Deployment Zone, and use the table below to calculate the amount of bonus Battle Points scored. Units at or below 25% of their starting Health Points (excluding Characters joined to the unit) count towards these bonus points with only half their Point Costs, rounding fractions up.

Percentage of Army Points in Zone (if playing with 4500 pts)	0%–10%	>10%–20%	>20%–25%	>25%–30%	>30%–35%	>35%–40%	>40%
	<b>Attacker</b>	-3	-2	-1	0	+1	+2
<b>Defender</b>	+3	+2	+1	0	-1	-2	-3

## 8. Strategic Objections

*When two factions both firmly believe they have the ultimate claim to the same land, there can only be war.*

### Deployment

Standard Deployment Type: Frontline Clash.

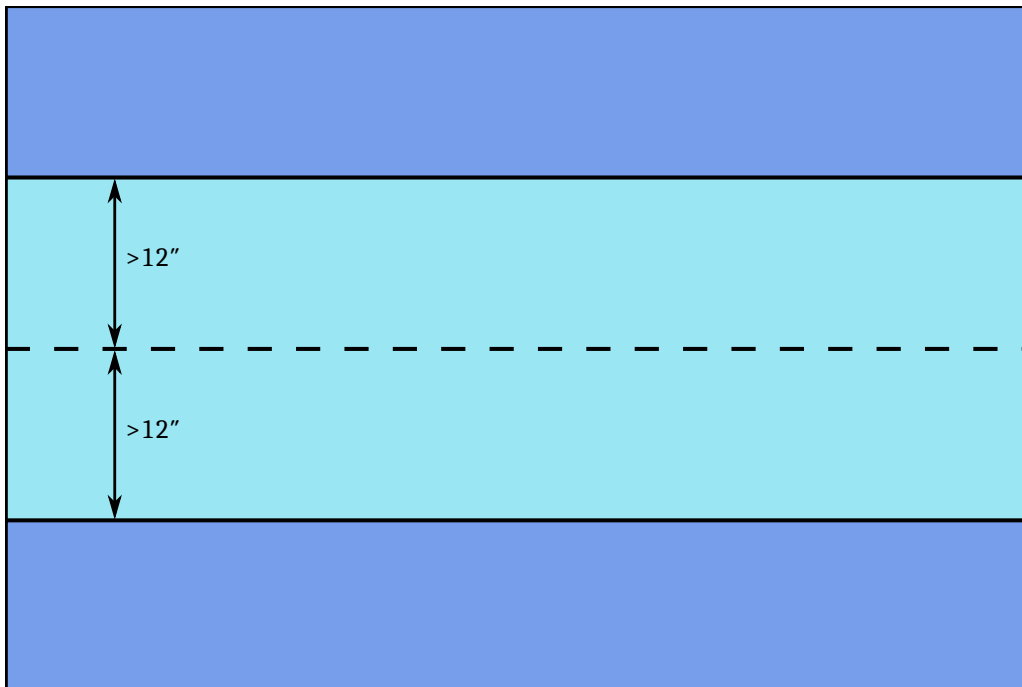

### Pre-Game Set-up

At the end of step 6 of the Pre-Game Sequence (immediately after determining Deployment Zones), both players must place a Strategic Objective anywhere on the Battlefield entirely outside their own Deployment Zone and at least 1" away from Impassable Terrain, starting with the player who chose their Deployment Zone.

## Scenario Special Rules



### Strategic Objective

single model

Height **Gigantic**  
Type **Construct**  
Base 100×100 mm

Global	Adv	Mar	Dis	Model Rules	
	<b>0"</b>	<b>0"</b>	<b>10</b>	<b>Themed, Unbreakable, Unmoveable</b>	
Defensive	HP	Def	Res	Arm	
	<b>7</b>	<b>0</b>	<b>7</b>	<b>0</b>	
Offensive	Att	Off	Str	AP	Agi
Strategic Objective	<b>0</b>	<b>0</b>	<b>0</b>	<b>0</b>	<b>0</b>

#### Model Rules

##### **Themed:** Universal Rule.

During step 7 of the Deployment Phase Sequence (after moving Vanguarding units but before rolling for first turn), each player must give their own Strategic Objective 2 upgrades from the list below starting with the player who chose their Deployment Zone:

- Magic Resistance (4)
- Aegis (5+)
- Fortitude (4+)
- Armour **set** to 4
- Toxic Attacks can **never** wound the model and attacks that are Poison Attacks against the model lose this Attack Attribute
- Resilience **set** to 8
- Distracting
- Hard Target (1)
- Health Points **set** to 9
- At the start of each Game Turn, roll a D6. On a 5+, this model Recovers 1 Health Point

##### **Unmoveable:** Universal Rule.

The Strategic Objective cannot move in any way once deployed, and for rules purposes its Pursuit and Overrun Distance is always 0". It cannot be joined by Characters.

## Winning the Scenario

A player is immediately declared the winner when their opponent's Strategic Objective is removed as a casualty or when all enemy units have been removed as casualties. If no winner has been declared after 7 Game Turns, the game is a draw.

## 9. A Proper Battle

*Kill one man, and you are a murderer. Kill millions of men, and you are a conqueror. Kill them all, and you are a god.*

### Deployment

Standard Deployment Type: Frontline Clash, with the exception that Deployment Zones are areas more than 9" away from the Centre Line.

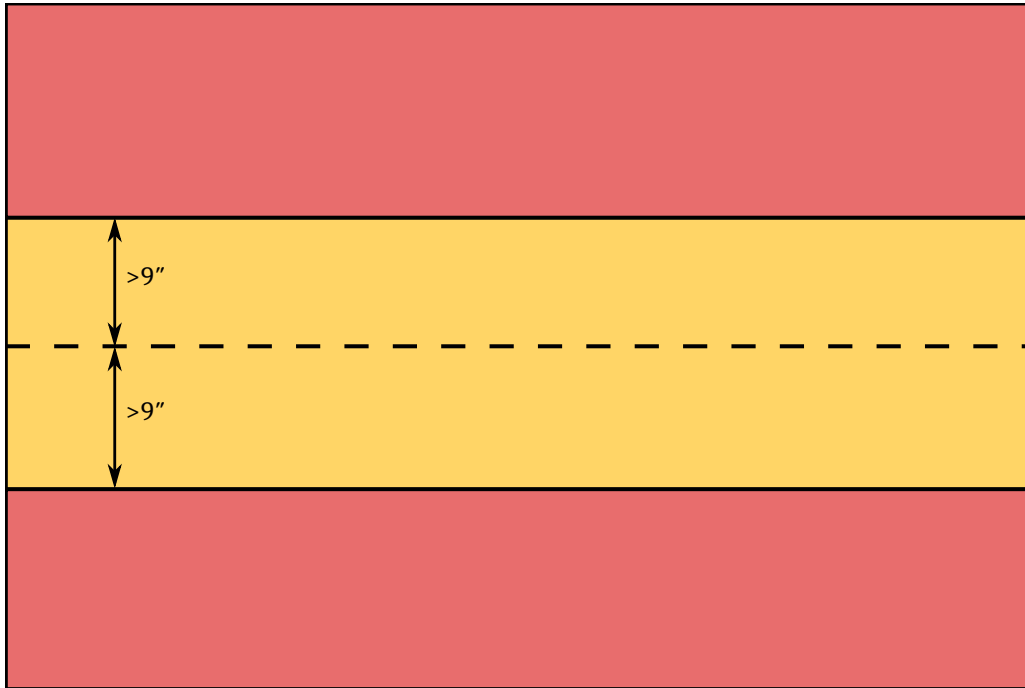

### Winning the Scenario

During the game, a player gains one Victory Counter if they are the first to be in any of the following situation:

- An enemy Scoring Unit is removed as a casualty.
- A friendly unit successfully Charges an enemy unit.
- An enemy unit of Gigantic Height or with War Machine is removed as a casualty.

At the end of the game, determine each player's most expensive unit that was removed as a casualty (based on the Point Costs on the Army List; in case of Combined Units, count joined Characters separately). The player with the less expensive unit out of these units gains 1 Victory Counter, and each player gains 1 Victory Counter if their opponent's General has been removed as a casualty.

The player with the most Victory Counters wins the game.

## 10. Weather the Storm

*To fight a battle in the midst of a blizzard is to lose all sense of what you're actually fighting for. Instead you struggle to simply stay alive.*

### Deployment

Standard Deployment Type: Frontline Clash.

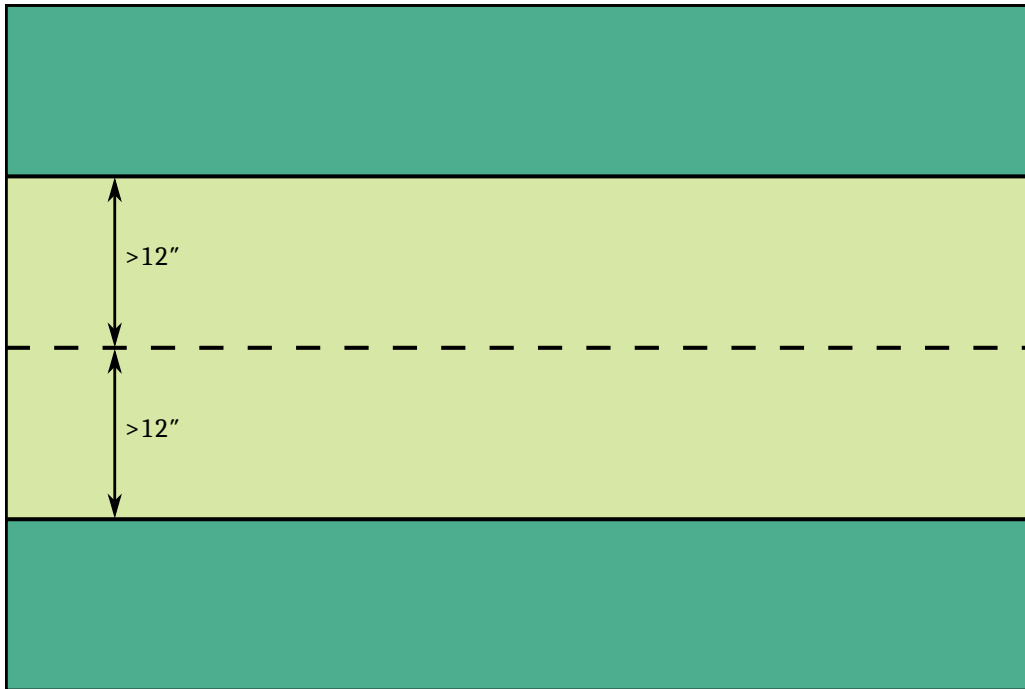

### Pre-Game Set-up

Set up the Battlefield with the following Terrain Features: 1–2 Forests and 1–3 small Impassable Terrains (approximately 3×3"). You may use the rules of Building the Battlefield in the Rulebook to randomly place those Terrain Features.

### Scenario Special Rules

At the beginning of each Player Turn, roll a D6 and multiply the result by 6: the result corresponds to the Distance of Sight, indicating how many inches the models can see into the blizzard. A roll of '1' means there is no visibility penalty that Player Turn.

A model or a unit cannot shoot, Charge, or otherwise specifically target a unit (including spells) farther away from this model or unit than the Distance of Sight.

In addition, during step 7 of the Deployment Phase Sequence (after moving Vanguarding units but before rolling for first turn), each player rolls a D6 and the corresponding effects in the table below are immediately applied to both armies. All effects remain in play until the end of the game unless specifically stated otherwise. These effects stack if both players roll the same result.

---

<b>1</b>	<b>Bitter Cold</b>	All models with an Armour of 2 or higher suffer -1 Advance Rate and -2 March Rate. If a model's Armour is modified to lower than 2, it no longer is affected, and if it is modified to 2 or higher, it will be affected.
<b>2</b>	<b>Hopelessly Lost</b>	Each player must nominate one enemy unit, starting with the player that chose their Deployment Zone. Move this unit 2D6" in a random direction (even if the unit normally couldn't move), keeping its orientation, otherwise following the rules for moving a Fleeing unit (like units having to take a Panic Test for friendly units Fleeing through their Unit Boundary). There are however two exceptions: the unit does not take any Dangerous Terrain Tests, and it follows the rules for Pursuing Off the Board if it comes into contact with the Board Edge. In this case, the unit returns in Game Turn 2 instead of Game Turn 1.
<b>3</b>	<b>Frostbite</b>	Roll 3D6. The result is used for both players. They must inflict this amount of Health Point losses among their own army, spreading them across their models however they want. Count the Victory Points for each player after the losses, as if the game was over. Note down the result. These Partial Victory Points will be used when determining who is the winner at the end of the game.
<b>4</b>	<b>Broken Morale</b>	Every model except the General suffers -1 Discipline.
<b>5</b>	<b>Poor Sight</b>	The range of Shooting Weapons, Artillery Weapons, and spells with type Missile is reduced by 6".
<b>6</b>	<b>Hazardous Landscape</b>	All models performing a movement other than a Reform during step 2 of the Movement Phase Sequence (Fleeing units and units with Random Movement) must take a Dangerous Terrain (1) Test.

---

## Winning the Scenario

Use the standard Victory Conditions of the Rulebook.

If the Frostbite effect was rolled at the beginning of the game, count the Victory Points as normal at the end of the game, including the losses from Frostbite, as if those losses happened during the game. The player who scored less Partial Victory Points when the Frostbite effect was applied gains a bonus of Victory Points equal to the difference in Partial Victory Points of both players, to compensate the fact that he effectively played with less Army Points.

## 11. Runaway Train

An Infernal Dwarves train loaded with valuable warpstone is headed for a safe passage. Two armies will both try to steal as much of the cargo as possible before the train makes its escape into the mountains.

### Deployment

Standard Deployment Type: Frontline Clash.

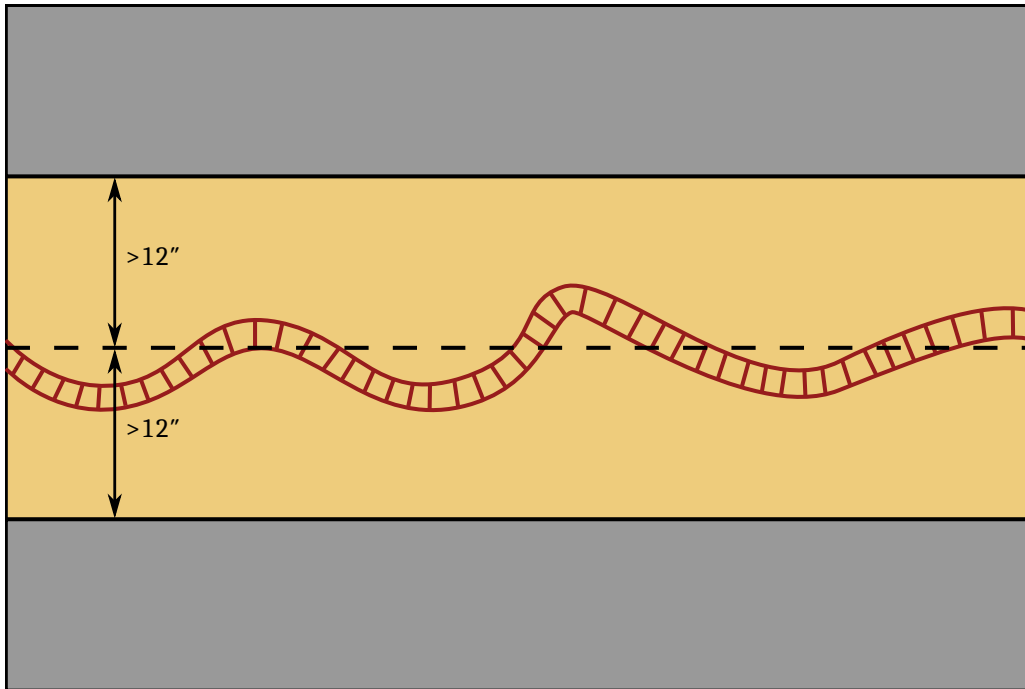

### Pre-Game Set-up

Set up the Battlefield with a line between the short Board Edges representing the track on which the Train will move. The line may be curved, however, the curves must be balanced with how close they are positioned to each player's Deployment Zone. Place an objective in the form of a Train with a base of approximately 6×2" on the tracks with its back against a randomly determined short Board Edge. For rules purposes, the train counts as Impassable Terrain.

### Scenario Special Rules

#### Fully Loaded Train

At the beginning of each Player Turn, roll 2D6: this is the distance in inches the Train travels forwards on the track.

If the Train comes into contact with a unit during its travel, it immediately stops (in base contact, without aligning) and the unit suffers 6D6 hits with Strength 4 and Armour Penetration 1. The unit is Shaken until the end of the Player Turn.

#### Winning the Scenario

At the start of each Player Turn, starting with Game Turn 2, the player with the closest Scoring Unit to the Train, as long as it is at least within 6", gains 1 Victory Counter. If there is a tie, no Victory Counter is awarded that Player Turn. A maximum of 6 Victory Counters total can be awarded this way.

At the end of the game, the player with the most Victory Counters wins the game.

## 12. In the Mountains

*Dwarves don't usually appreciate when foreigners march on their territory without authorization. I was merely passing by, bringing my troops as a reinforcement for a most important war. I knew I would have been lucky if the dwarves had let me go through the valley, but walking around their territory would have taken more time than I can afford. Now I just have make most of my troops reach the other side.*

### Deployment

In this scenario, one player takes on the role of the Attacker while the other player is the Defender. Use a standard 72"×48" board. Randomly choose one short Board Edge to be the Attacker's Edge. The opposite short Board Edge is the Defender's Edge.

Place two Hills, one along each long Board Edge, as long as the Board Edges and with a width of 10". The long edges of the Hills facing towards the centre of the board are called Hill Lines. Put three 1×12" Impassable Terrains on each Hill Line (six in total), parallel to the Hill Lines, and with their centres on the Hill Lines at 6", 36", and 66" from the Attacker's Edge. Then move each of them 2D6" along the Hill Lines, randomising in which direction (if it can't be moved there, don't move it at all).

Finally, add three Ruins on the Centre Line at 12", 36", and 60" from the Attacker's Edge, and move them 2D6" in a random direction.

The Attacker's Deployment Zone is an area less than 14" away from the Centre Line and less than 20" away from the Attacker's Edge. The Defender's Deployment Zone correspond to both Hills, at least 24" away from the Attacker's Edge.

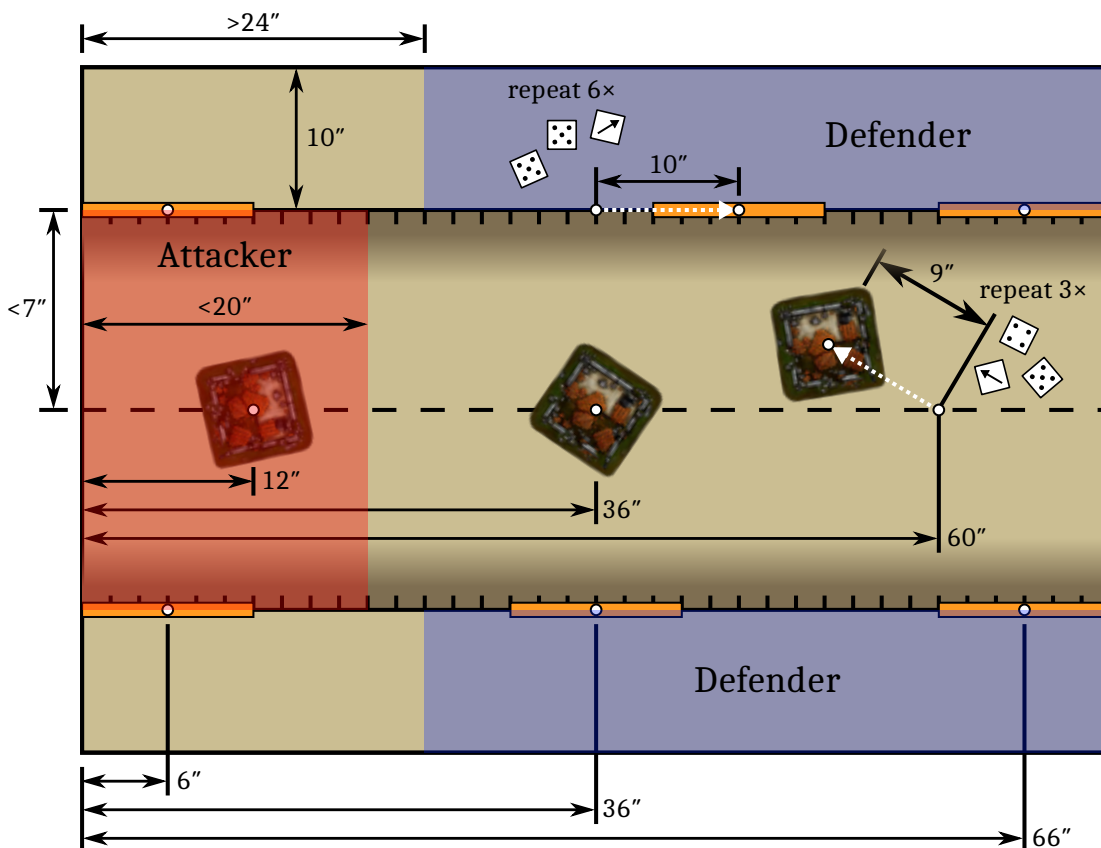



## **Pre-Game Set-up**

The Defender's army must be Infernal Dwarves or Dwarven Holds. Its Army Points are limited to 3500 pts, but the limit of Hail of the Gods is increased to max. 45%, Barrage to max. 30%, Clan's Thunder to max. 50%, and Engines of War to max. 30%. The Attacker's army can be from any Army Book and up to 4500 pts, but units with Fly are limited to max. 25%.

The Deployment Phase Sequence is slightly modified. At first the Defender deploys their units with War Machine, plus one unit for every unit with Scout the Attacker has in their Army List (regardless if these units use Special Deployment or not). Then the Attacker deploys their entire army, including their units with Scout, but not including units using other Special Deployment such as Ambush. The units must be deployed within 48" of the Attacker's Edge. Finally, the Defender deploys the rest of their army and their Scouts as usual.

## **Winning the Scenario**

The game ends after 7 Game Turns. Count the Victory Points as usual. On top of that, when an Attacker's unit finishes a move within 10" of the Defender's Edge, and is not Engaged in Combat nor Fleeing, the Attacker can remove this unit from the game. The Point Costs of all units removed this way count towards the Attacker's total Victory Points. Moreover, all of the Attacker's units that are farther than 10" of the Defender's Edge at the end of the game award their full Point Costs to the Defender, as if they had been removed as casualties.

# Add-Ons

Add-ons are rules that can be added to other scenarios to customise your games.

## Mirror Match

Your face in the mirror doesn't look quite right! Before determining the Deployment Zones, switch armies with each other. In this game, you will both play using the models and the Army List of your opponent.

**Only use this add-on if both players are perfectly okay with another person handling their miniatures!**

## Unhinged Flux

This is an alternative deck of Flux Cards that replaces the ordinary deck. In addition, when using this deck, there is no limit to how many Veil Tokens can be used or how many Magic Dice can be generated during Siphon the Veil. Ignore the Veil Token Limits in the Rulebook.

### Flux Card 1

**4 Magic Dice**  
(both players)

**4 Veil Tokens**  
(Active Player)

All Miscasts this phase gain  
a +1 Miscast Modifier

### Flux Card 2

**4 Magic Dice**  
(both players)

**5 Veil Tokens**  
(Active Player)

The cost to exchange Veil Tokens for  
Magic Dice is increased by one  
(normally to 4:1)

### Flux Card 3

**5 Magic Dice**  
(both players)

**8 Veil Tokens**  
(Active Player)

One use only. Whenever the Active  
Player passes a Casting Attempt, the  
Reactive Player may force the Active  
Player to reroll the casting roll

### Flux Card 4

**5 Magic Dice**  
(both players)

**7 Veil Tokens**  
(Active Player)

### Flux Card 5

**6 Magic Dice**  
(both players)

**12 Veil Tokens**  
(Active Player)

The Reactive Player gains 3  
Veil Tokens

### Flux Card 6

**6 Magic Dice**  
(both players)

**3 Veil Tokens**  
(Active Player)

One use only. The Active Player can  
reroll a non-Miscast casting roll

### Flux Card 7

**7 Magic Dice**  
(both players)

**2 Veil Tokens**  
(Active Player)

The cost to exchange Veil Tokens for  
Magic Dice is decreased by one, to a  
minimum of 2:1

### Flux Card 8

**8 Magic Dice**  
(both players)

**7 Veil Tokens**  
(Active Player)

All Miscasts this phase  
suffer a -1 Miscast Modifier

## Wild Miscast

The Veil has been thinned out dangerously in the surrounding area, saturating the landscape with magic. Using it comes more easily than elsewhere, but also with less predictable results.

Use the standard rules for Miscasts, with the exception that a Miscast happens when **two** or more Magic Dice roll the same value and that there are no Miscast Modifiers for using 3 or 5 Magic Dice. In addition, the Miscast table is changed. If a casting roll contains two sets of dice with identical values, only the one with the most dice leads to a Miscast. If both sets contain two dice, then only the one with the highest value on the dice counts.

Value	Miscast Effects												
	Apply the effects of 2 and higher after resolving the effects of the spell and any Attribute Spell.												
<b>0 or lower</b>	No effect.												
<b>Broken Concentration.</b>													
The Casting Attempt fails (apply Fizzle as normal). The Active Player immediately gains...													
<b>1</b>	<table border="1"> <thead> <tr> <th>Double</th> <th>Triple</th> <th>Quadruple</th> <th>Quintuple</th> </tr> </thead> <tbody> <tr> <td>1</td> <td>D3</td> <td>1</td> <td>D3</td> </tr> <tr> <td colspan="2">additional Veil Tokens</td> <td colspan="2">additional Magic Dice</td> </tr> </tbody> </table>	Double	Triple	Quadruple	Quintuple	1	D3	1	D3	additional Veil Tokens		additional Magic Dice	
Double	Triple	Quadruple	Quintuple										
1	D3	1	D3										
additional Veil Tokens		additional Magic Dice											
<b>Witchfire.</b> The Caster's unit suffers...													
<b>2</b>	<table border="1"> <thead> <tr> <th>Double</th> <th>Triple</th> <th>Quadruple</th> <th>Quintuple</th> </tr> </thead> <tbody> <tr> <td>D3</td> <td>D6</td> <td>2D6</td> <td>3D6</td> </tr> </tbody> </table> <p>... hits with Strength 5, Armour Penetration 2, and Magical Attacks.</p>	Double	Triple	Quadruple	Quintuple	D3	D6	2D6	3D6				
Double	Triple	Quadruple	Quintuple										
D3	D6	2D6	3D6										
<b>Magical Inferno.</b> All units within 12" of the Caster suffer...													
<b>3</b>	<table border="1"> <thead> <tr> <th>Double</th> <th>Triple</th> <th>Quadruple</th> <th>Quintuple</th> </tr> </thead> <tbody> <tr> <td>D3</td> <td>D6</td> <td>2D6</td> <td>3D6</td> </tr> </tbody> </table> <p>... hits with Strength 4, Armour Penetration 1, and Magical Attacks.</p>	Double	Triple	Quadruple	Quintuple	D3	D6	2D6	3D6				
Double	Triple	Quadruple	Quintuple										
D3	D6	2D6	3D6										
<b>Amnesia.</b>													
<b>4</b>	<ul style="list-style-type: none"> <li>• <b>Double:</b> The Caster cannot cast the Miscast spell in the following Game Turn.</li> <li>• <b>Triple:</b> The Caster cannot cast the Miscast spell anymore this game.</li> <li>• <b>Quadruple:</b> The enemy Wizard closest to the Caster may immediately and automatically cast the Miscast spell so long as it can fulfill the usual restrictions (Line of Sight, range, etc.).</li> <li>• <b>Quintuple:</b> The enemy Wizard closest to the Caster may immediately and automatically cast the Miscast spell (which the Active Player cannot dispel), so long as it can fulfill the usual restrictions (Line of Sight, range, etc.). In addition, the enemy Wizard knows the spell for the rest of the game.</li> </ul>												
<b>Possession.</b> The Caster gains Battle Focus, Frenzy, Lethal Strike, Unbreakable, ...													
<b>5</b>	<ul style="list-style-type: none"> <li>• <b>Double:</b> +1 Attack Value, and +1 Offensive Skill.</li> <li>• <b>Triple:</b> +2 Attack Value, +2 Offensive Skill, +1 Strength, and +1 Resilience.</li> <li>• <b>Quadruple:</b> +3 Attack Value, +3 Offensive Skill, +2 Strength, +2 Resilience, and +1 Armour.</li> <li>• <b>Quintuple:</b> +4 Attack Value, +4 Offensive Skill, +3 Strength, +1 Armour Penetration, +3 Resilience, and +2 Armour.</li> </ul> <p>The Caster's unit suffers...</p> <table border="1"> <thead> <tr> <th>Double</th> <th>Triple</th> <th>Quadruple</th> <th>Quintuple</th> </tr> </thead> <tbody> <tr> <td>-2 Discipline</td> <td>-3 Discipline</td> <td>-4 Discipline</td> <td>-5 Discipline</td> </tr> </tbody> </table>	Double	Triple	Quadruple	Quintuple	-2 Discipline	-3 Discipline	-4 Discipline	-5 Discipline				
Double	Triple	Quadruple	Quintuple										
-2 Discipline	-3 Discipline	-4 Discipline	-5 Discipline										
<b>Implosion.</b>													
<b>6 or more</b>	<ul style="list-style-type: none"> <li>• <b>Double:</b> The Caster suffers 2 hits that wound on 4+ with Armour Penetration 10 and Magical Attacks.</li> <li>• <b>Triple:</b> The Caster suffers 4 hits that wound on 4+ with Armour Penetration 10 and Magical Attacks.</li> <li>• <b>Quadruple:</b> The Caster's model is removed as a casualty (with no saves of any kind allowed).</li> <li>• <b>Quintuple:</b> The Caster's unit is removed as a casualty (with no saves of any kind allowed).</li> </ul>												